

## SINGLE NEEDLE CLOTH GUIDE ADJUSTABLE FEET

G10-CRL

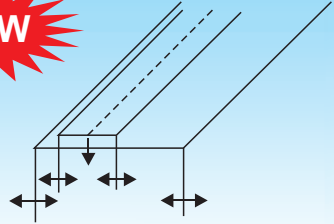

1. 可以調整左·右擋邊尺寸。

2. 車縫布條·可調整大小·0~20mm

1. CAN ADJUSTABLE THE SIZE OF BOTH SIDE ON THE EDGE.

2. SEAM CLOTH CAN ADJUSTABLE THE TAPE SIZE. 0~20mm

## ADJUSTABLE CONCEALED SEAM COMPENSATING FEET

NR-31G



NL-31G

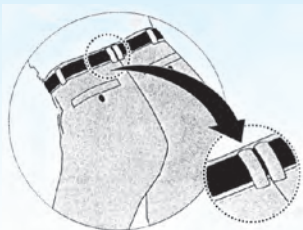

CONCEALED SEAM  
FOR SKIRTS OF SLACKS

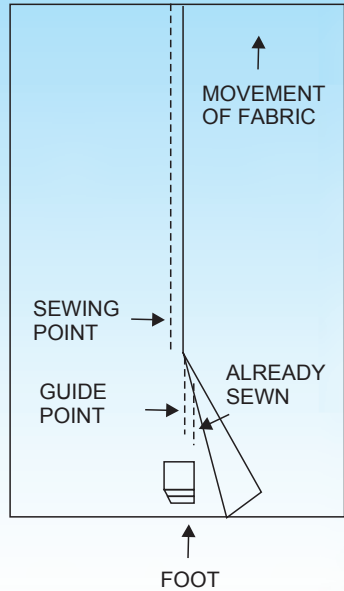

## COMPENSATING FEET FOR KNIT



### CR1/16NK

- CR1/32NK (210H)
- CR1/16NK (211NH)
- CR1/32K (21H)
- CR1/16K (211H)
- CR3/32K (2111/2H)
- CR1/8K (212H)
- CR5/32K (212 1/2H)
- CR3/16K (213H)
- CR1/4K (214H)
- CR5/16K (215H)
- CR3/8K (216H)
- CR1/2K (218H)



### CL1/16NK

- CL1/32NK (220H)
- CL1/16NK (221NH)
- CL1/32K (22H)
- CL1/16K (221H)
- CL3/32K (221 1/2H)
- CL1/8K (222H)
- CL5/32K (222 1/2H)
- CL3/16K (223H)
- CL1/4K (224H)
- CL5/16K (225H)
- CL3/8K (226H)
- CL1/2K (228H)

## COMPENSATING FEET



### CR1/16N

- CR1/32NN (210RN)
- CR 1/16NN(211NN)
- CR1/32N (210R)
- CR1/16N (211N)
- CR1/32E (21R)
- CR1/16E (211R)
- CR3/32E (2111/2)
- CR1/8E (212R)
- CR5/32E (212 1/2)
- CR3/16E (213R)
- CR1/4E (214R)
- CR5/16E (215R)
- CR3/8E (216R)
- CR1/2E (218R)



### CL1/16N

- CL1/32NN(220LN)
- CL 1/16NN(221NN)
- CL1/32N (220L)
- CL1/16N (221N)
- CL1/32E (22L)
- CL1/16E (221L)
- CL3/32E (221-1/2)
- CL1/8E (222L)
- CL5/32E (222 1/2)
- CL3/16E (223L)
- CL1/4E (224L)
- CL5/16E (225L)
- CL3/8E (226L)
- CL1/2E (228L)

## COMPENSATING FEET FOR KNIT (STRENGTH)

USE ON THICKNESS OF FABRICS THE SIDE SCREW  
CAN EASY HOLD THE GUIDE ,SO THE CLOTH CAN SMOOTHLY

### CR1/16NS

**NEW**

- |          |          |
|----------|----------|
| SIZE     |          |
| CR1/32NS | CR5/32ES |
| CR1/16NS | CR3/16ES |
| CR1/32ES | CR1/4ES  |
| CR1/16ES | CR5/16ES |
| CR3/32ES | CR3/8ES  |
| CR1/8ES  | CR1/2ES  |



### CL1/16NS

**NEW**

- |          |          |
|----------|----------|
| SIZE     |          |
| CL1/32NS | CL5/32ES |
| CL1/16NS | CL3/16ES |
| CL1/32ES | CL1/4ES  |
| CL1/16ES | CL5/16ES |
| CL3/32ES | CL3/8ES  |
| CL1/8ES  | CL1/2ES  |



## COMPENSATING FEET



**CR15N**

- CR-10N-1.0mm
- CR-15N-1.5mm
- CR-10 -1.0mm
- CR-15 -1.5mm
- CR-20 -2.0mm
- CR-25 -2.5mm
- CR-30 -3.0mm
- CR-40 -4.0mm
- CR-50 -5.0mm
- CR-60 -6.0mm
- CR-65 -6.5mm
- CR-70 -7.0mm
- CR-80 -8.0mm
- CR-90 -9.0mm
- CR-100 -10 mm
- CR-110 -11 mm
- CR-130 -13 mm



**CL15N**

- CL-10N-1.0mm
- CL-15N-1.5mm
- CL-10 -1.0mm
- CL-15 -1.5mm
- CL-20 -2.0mm
- CL-25 -2.5mm
- CL-30 -3.0mm
- CL-40 -4.0mm
- CL-50 -5.0mm
- CL-60 -6.0mm
- CL-65 -6.5mm
- CL-70 -7.0mm
- CL-80 -8.0mm
- CL-90 -9.0mm
- CL-100 -10 mm
- CL-110 -11 mm
- CL-130 -13 mm

## COMPENSATING FEET(SHORT TOE)



**CR1/16**

- CR1/32
- CR1/16
- CR3/32
- CR1/8
- CR5/32
- CR3/16
- CR1/4
- CR5/16
- CR3/8
- CR1/2



**CL1/16**

- CL1/32
- CL1/16
- CL3/32
- CL1/8
- CL5/32
- CL3/16
- CL1/4
- CL5/16
- CL3/8
- CL1/2

### COMPENSATING FEET FOR KNIT (STRENGTH)

USE ON THICKNESS OF FABRICS THE SIDE SCREW CAN EASY HOLD THE GUIDE, SO THE CLOTH CAN SMOOTHLY (SHORT TOE)



- | SIZE (RIGHT) | SIZE (LEFT) |
|--------------|-------------|
| CR1/32S      | CL1/32S     |
| CR1/16S      | CL1/16S     |
| CR3/32S      | CL3/32S     |
| CR1/8S       | CL1/8S      |
| CR5/32S      | CL5/32S     |
| CR3/16S      | CL3/16S     |
| CR1/4S       | CL1/4S      |
| CR5/16S      | CL5/16S     |
| CR3/8S       | CL3/8S      |
| CR1/2S       | CL1/2S      |

### ADJUSTABLE PRESSET FOOT (EASY OPERATE DON'T STOP)

**P351KS**

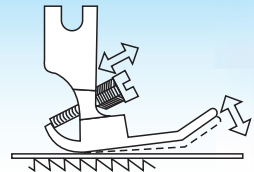

## COMPENSATING FEET(DOUBLE)



**CD3/16 DOUBLE**  
 CDN-00 (230)  
 CD-00 (23)  
 CD-10 (1.0mm)  
 CD-15 (1.5mm)  
 CD-20 (2.0mm)  
 CDN-1/32(D23N)  
 CD-1/32 (D23)  
 CDN-1/16(D231N)  
 CD-1/16 (D231)  
 CD-1/8 (D232)  
 CD-3/16 (D233)  
 CD-1/4 (D234)

**23-14-24 DOUBLE**



23-13-23  
 (1/32 -3/16-3/16)  
 231-13-23  
 (1/16 -3/16-3/16)  
 23-14-24  
 (1/32 -1/4-1/4)  
 231-14-24  
 (1/16-1/4-1/4)  
 23-15-25  
 (1/32-5/16-5/16)  
 231-15-25  
 (1/16-5/16-5/16)

990474-0-01

## DUAL COMPENSATING FEET

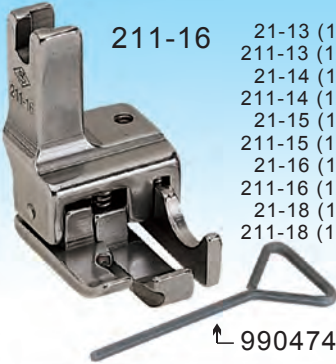

**211-16**  
 211-13 (1/32x3/16)  
 211-13 (1/16x3/16)  
 21-14 (1/32x1/4)  
 211-14 (1/16x1/4)  
 21-15 (1/32x5/16)  
 211-15 (1/16x5/16)  
 21-16 (1/32x3/8)  
 211-16 (1/16x3/8)  
 21-18 (1/32x1/2)  
 211-18 (1/16x1/2)

↑ 990474-0-01



**8-48**  
 8-32(1/32-1/8)  
 8-48(1/32-3/16)  
 8-64(1/32-1/4)  
 8-80(1/32-5/16)  
 16-32(1/16-1/8)  
 16-48(1/16-3/16)  
 16-64(1/16-1/4)  
 16-80(1/16-5/16)

## PRESSER FOOT WITH GUIDE



**SP18-1/4**  
 SP18-1/32  
 SP18-1/16  
 SP18-3/32  
 SP18-1/8  
 SP18-3/16  
 SP18-1/4  
 SP18-5/16  
 SP18-3/8



**SP18L-1/4**  
 SP18L-1/32  
 SP18L-1/16  
 SP18L-3/32  
 SP18L-1/8  
 SP18L-3/16  
 SP18L-1/4  
 SP18L-5/16  
 SP18L-3/8



## COMPENSATING TEFLON FEET (LIGHT)



### RF1/16NK

- RF1/32NK (PF210)
- RF1/16NK (PF211N)
- RF1/32K (PF21R)
- RF1/16K (PF211R)
- RF3/32K (PF2111/2)
- RF1/8K (PF212R)
- RF5/32K (PF212 1/2)
- RF3/16K (PF213R)
- RF1/4K (PF214R)
- RF5/16K (PF215R)
- RF3/8K (PF216R)
- RF1/2K (PF218R)

薄物(LIGHT)



### LF1/16NK

- LF1/32NK (PF220L)
- LF1/16NK (PF221N)
- LF1/32K (PF22L)
- LF1/16K (PF221L)
- LF3/32K (PF221 1/2)
- LF1/8K (PF222L)
- LF5/32K (PF222 1/2)
- LF3/16K (PF223L)
- LF1/4K (PF224L)
- LF5/16K (PF225L)
- LF3/8K (PF226L)
- LF1/2K (PF228L)

薄物(LIGHT)

## COMPENSATING TEFLON FEET (REGULAR)



### RF1/16N

- RF1/32N
- RF1/16N
- RF1/32
- RF1/16
- RF3/32
- RF1/8
- RF5/32
- RF3/16
- RF1/4
- RF5/16
- RF3/8
- RF1/2



### LF1/16N

- LF1/32N
- LF1/16N
- LF1/32
- LF1/16
- LF3/32
- LF1/8
- LF5/32
- LF3/16
- LF1/4
- LF5/16
- LF3/8
- LF1/2

## COMPENSATING TEFLON FEET (REGULAR)



### RF15N

- RF-10N-1.0mm
- RF-15N-1.5mm
- RF-10 -1.0mm
- RF-15 -1.5mm
- RF-20 -2.0mm
- RF-25 -2.5mm
- RF-30 -3.0mm
- RF-40 -4.0mm
- RF-50 -5.0mm
- RF-60 -6.0mm
- RF-65 -6.5mm
- RF-70 -7.0mm
- RF-80 -8.0mm
- RF-90 -9.0mm
- RF-100 -10 mm
- RF-120 -12 mm
- RF-130 -13 mm



### LF15N

- LF-10N-1.0mm
- LF-15N-1.5mm
- LF-10 -1.0mm
- LF-15 -1.5mm
- LF-20 -2.0mm
- LF-25 -2.5mm
- LF-30 -3.0mm
- LF-40 -4.0mm
- LF-50 -5.0mm
- LF-60 -6.0mm
- LF-65 -6.5mm
- LF-70 -7.0mm
- LF-80 -8.0mm
- LF-90 -9.0mm
- LF-100 -10 mm
- LF-120 -12 mm
- LF-130 -13 mm

## TEFLON HINGED RASING FEET

### CF811 RIGHT



- CF810 -1/32
- CF811 -1/16
- CF8115-3/32
- CF812 -1/8
- CF813 -3/16
- CF814 -1/4
- CF815 -5/16
- CF816 -3/8
- CF818 -1/2

### CF811L LEFT



- CF810L -1/32
- CF811L -1/16
- CF8115L- 3/32
- CF812L -1/8
- CF813L -3/16
- CF814L -1/4
- CF815L -5/16
- CF816L -3/8
- CF818L -1/2

### TEFLON FEET (LIGHT W/TAIL)



- SIZE
- PF-231-HEAVY (CF-231-HEAVY)
  - PF-241-MEDIUM (CF-241-MEDIUM)
  - PF-251-LIGHT (CF-251-LIGHT)

### TEFLON FEET (LIGHT WITHOUT TAIL)



- SIZE
- PF-131-HEAVY (CF-131-HEAVY)
  - PF-141-MEDIUM (CF-141-MEDIUM)
  - PF-151-LIGHT (CF-151-LIGHT)

### TEFLON FEET (LIGHT)

#### PFK161 (CFK161)



- SIZE
- PFK-161-LIGHTEST (CFK-161-LIGHTEST)
  - PFK-261-LIGHTEST W/TAIL (CFK-261-LIGHTEST W/TAIL)



SOLID THE CLOTH PROOF MOTION

### TEFLON FOOT (LINE ON THE CENTER EDGE GUIDE)

#### PF00 (CF00)



## TEFLON FEET (ZIPPER)



### SIZE

CF36N	-4.6mm
CF363	-4.8mm
CF363V	-4.8mm
CF363VNF	-4.8mm
CF3CH	-4.8mm
CF3CSH	-4.8mm
CF36	-8mm
CF361	-8mm
CF36W	-10mm



### SIZE

CF36LN	-4.6mm
CF36L	-8mm
CF360	-8mm
CF58N	-8mm
CF36LW	-10mm
CF35	-11mm
CF351	-11mm
CF351W	-12.7mm

## TEFLON INVISIBLE FOOT



PF518N  
(CF518N)



PF518L  
(CF518L)

## HINGED RASING FEET



P811 RIGHT

P810	(12463H 1/32)
P811	(12463H 1/16)
P8115	(12463H 3/32)
P812	(12463H 1/8)
P813	(12463H 3/16)
P814	(12463H 1/4)
P815	(12463H 5/16)
P816	(12463H 3/8)
P818	(12463H 1/2)



P811L LEFT

P810L	(L12463H1/32)
P811L	(L12463H 1/16)
P8115L	(L12463H 3/32)
P812L	(L12463H1/8)
P813L	(L12463H3/16)
P814L	(L12463H1/4)
P815L	(L12463H5/16)
P816L	(L12463H3/8)
P818L	(L12463H1/2)

## HINGED PIPING FEET

### P69RH-3/16 RIGHT

P69RH1/16 (R36069H1/16)  
 P69RH1/8 (R36069H1/8)  
 P69RH3/16 (R36069H3/16)  
 P69RH1/4 (R36069H1/4)



### P69LH-3/16 LEFT

P69LH1/16 (L36069H1/16)  
 P69LH1/8 (L36069H1/8)  
 P69LH3/16 (L36069H3/16)  
 P69LH1/4 (L36069H1/4)



## SPECIAL PIPING FEET

### P31C1/4 RIGHT

P31C1/8 (12435R 1/8)  
 P31C3/16 (12435R 3/16)  
 P31C1/4 (12435R 1/4)



### P301C1/4 LEFT

P301C1/8 (31358L1/8)  
 P301C3/16 (31358L3/16)  
 P301C1/4 (31358L1/4)



## SPECIAL PIPING FEET

### P69R3/8 RIGHT

P69R1/16 (36069R 1/16)  
 P69R1/8 (36069R 1/8)  
 P69R3/16 (36069R 3/16)  
 P69R1/4 (36069R 1/4)  
 P69R3/8 (36069R 3/8)  
 P69R1/2 (36069R 1/2)  
 (26650R 1/8)



### P69L3/8 LEFT

P69L1/16 (36069L 1/16)  
 P69L1/8 (36069L 1/8)  
 P69L3/16 (36069L 3/16)  
 P69L1/4 (36069L 1/4)  
 P69L3/8 (36069L 3/8)  
 P69L1/2 (36069L 1/2)  
 (26650L 1/8)





## DOUBLE PIPING FEET



**P69D-1/4 (DOUBLE)**  
 P69D1/16 (36069DG 1/16)  
 P69D1/8 (36069DG 1/8)  
 P69D3/16 (36069DG 3/16)  
 P69D1/4 (36069DG 1/4)  
 (26650DG 1/8)

## BINDER FOOT



**P37**  
 P39 -PLAIN  
 P37 -SMALLGROVE  
 P37M-MED. GROVE  
 P37W-LARGE GROVE

## BINDER FEET



**A10-01**  
 (12142C)  
 A10-01- 3/4  
 A10-01-7/8  
 A10-01-1"  
 A10-01-1 1/8  
 A10-01-1 1/4  
 A10-01-1 3/8  
 A10-01-1 1/2

## BINDER FOOT (HINGED)



**S70F 1/8**  
 S70F-1/16  
 S70F-1/8  
 S70F-3/16  
 S70F-1/4  
 S70F-5/16  
 S70F-3/8  
 S70F-1/2

## HEMMING & FOLDING FEET

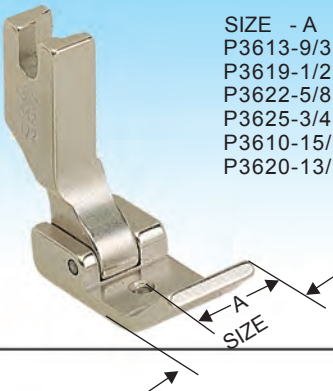

SIZE - A  
 P3613-9/32  
 P3619-1/2  
 P3622-5/8  
 P3625-3/4  
 P3610-15/64  
 P3620-13/32

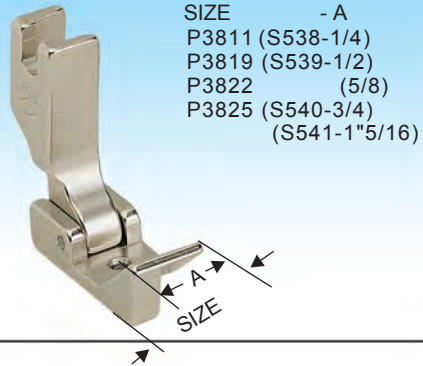

SIZE - A  
 P3811 (S538-1/4)  
 P3819 (S539-1/2)  
 P3822 (5/8)  
 P3825 (S540-3/4)  
 (S541-1"5/16)

## HINGED BINDING FEET

### NARROW

RIGHT  
CHNR-1/32  
(KR-1-1/32)  
CHNR-1/16  
(KR-1-1/16)  
LEFT  
CHNL-1/32  
(KL-1-1/32)  
CHNL-1/16  
(KL-1-1/16)



### 520-4



## COMPENSATING BINDING FEET

### SIZE

CB 3/4 (601)  
CB 1" (602)  
CB 1-1/8 (603)  
CB 1-1/4 (604)



## HEMMING & FOLDING FEET

### S543(CHN)



### S544(CHW)



### 12142AHB



### SR-1



## SOLID FOLDING FEET

### P311 (12143)



### P33 (12142)



### P34



### P344



## BINDING FOOT

**P983**  
(25983)



**S545**  
(P38)



## SHIRRING FEET

**P50**

SIZE  
P50N (120828N)  
P50 (120828)  
P50M (120828M)  
P50H (120828H)



## 3 SCROLL HEMMER FT

**2 1/2**

SIZE  
1 (160344-1/16)  
1 1/2 (120802-1 1/2)  
2 (120938-3/32)  
2 1/2 (120803-1/8)  
02 (1/8)  
3 (120804-5/32)  
4 (120805-3/16)  
04 (3/16)  
5 (120940-7/32)  
6 (120806-1/4)  
06 (1/4)



## ELASTIC SHIRRING FEET

**A227**

SIZE  
A227-1/8 (S537-1/8)  
A227-3/16 (S537-3/16)  
A227-1/4 (S537-1/4)  
A227-5/16 (S537-5/16)  
A227-3/8 (S537-3/8)  
A227-1/2 (S537-1/2)



## BINDER FEET

**S532(P312SB)**



## ADJUSTABLE TAPE FEET

**S534(A225)**

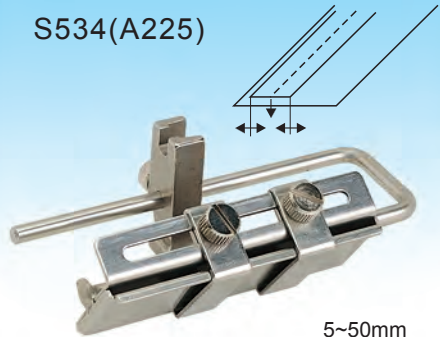

5~50mm

## HINGED TUBE FEET

### S10C-1/2

#### SIZE(CENTER)

- S10C-1/8 (P318C 1/8)
- S10C-3/16 (P3316C 3/16)
- S10C-1/4 (P314C 1/4)
- S10C-5/16 (P3516C 5/16)
- S10C-3/8 (P338C 3/8)
- S10C-1/2 (P312C 1/2)
- S10C-5/8 (P358C 5/8)
- S10C-3/4 (P334C 3/4)
- S10C-1" (P325C1")



### S10R-1/2

#### SIZE(RIGHT)

- S10R-1/8 (P318R 1/8)
- S10R-3/16 (P3316R 3/16)
- S10R-1/4 (P314R 1/4)
- S10R-5/16 (P3516R 5/16)
- S10R-3/8 (P338R 3/8)
- S10R-1/2 (P312R 1/2)
- S10R-5/8 (P358R 5/8)
- S10R-3/4 (P334R 3/4)
- S10R-1" (P325R1")



## HINGED TUBE FEET

### S10L-1/2

#### SIZE(LEFT)

- S10L-1/8 (P318L1/8)
- S10L-3/16 (P3316L 3/16)
- S10L-1/4 (P314L1/4)
- S10L-5/16 (P3516L 5/16)
- S10L-3/8 (P338L3/8)
- S10L-1/2 (P312L1/2)
- S10L-5/8 (P358L5/8)
- S10L-3/4 (P334L3/4)
- S10L-1" (P325L1")



## TOP STITCH FEET

### P14

#### SIZE

- P10 (36465-1/32)
- P11 (36465-1/16)
- P115 (36465-3/32)
- P12 (36465-1/8)
- P13 (36465-3/16)
- P14 (36465-1/4)
- P15 (36465-5/16)
- P16 (36465-3/8)
- P18 (36465-1/2)
- P01 (36464N)(P10~P14)
- P01W (36464W)(P15~18)



## SHIRRING FEET

### S952(P952)



### S950(P950)



### P5R



### P5W



## SOLID ZIPPER FEET

S530S



S531L



P3  
(165010)



P3C  
(40322)



## SOLID ZIPPER FEET

P3CS  
(40322CS)



P311N  
(12435N)



P301N  
(31358N)



P31  
(12435W)



## ZIPPER FEET

P301  
(31358W)



P363V  
(165010H)



P363  
(40322SH)



P36N  
(12435HN)





## HINGED ZIPPER FEET

**P36**  
(12435HW)



**P36W**  
(12435HXW)



**D36NH**  
DOUBLE



## SOLID CONCEALED ZIPPER FEET (PLASTIC)

**2CJ1(尖)**  
(NP-63P-2)



WHITE/WITH FRONT GUIDE

## HINGED ZIPPER FEET

**P36LN**  
(31358HN)



**P36L**  
(31358HW)



**D36H**  
DOUBLE



## SOLID CONCEALED ZIPPER FEET (PLASTIC)

**3CJ1(平)**  
(NP-63P-1)

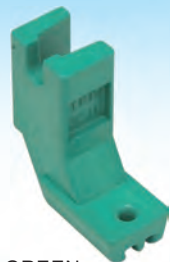

GREEN

## HINGED ZIPPER FEET

**P36LW**  
(31358HXW)



**P360**  
(121947H)



**P361**  
(121905H)



## ZIPPER FOOT

**S510**  
ENTER GUIDE FOOT



## HINGED INVISIBLE ZIPPER FEET

S518L



S518N-G  
S518N



S518NE



S518 SIZE  
S518-2.0mm  
S518H-2.5mm



## INVISIBLE ZIPPER FEET

S518S



S518A



P946  
(121946)



P58N  
(142058N)



P58W  
(142058W)



P144H  
(12144H)



SIZE  
P144H  
(12144H)  
P144HL  
(12144HLD)  
P144HLB  
(12144HLB)

P35  
(24983)



P35K  
(24983K)



LIGHT (薄物用)

**HINGED STANDARD FOOT**

**P351 (52427)**



**P352**



**P351K**



LIGHT  
(薄物用)

**P193  
(19336)**



**QUILTER & GUIDE FEET**

**S524  
7/32"~1"**



**P81  
(S523)  
1/32"~3/4"**



**P801  
1/32"~3/4"**



**P803  
3/16"~7/8"**



**QUILTER & GUIDE FEET**

**P723  
(S521)  
3/16"~2"**

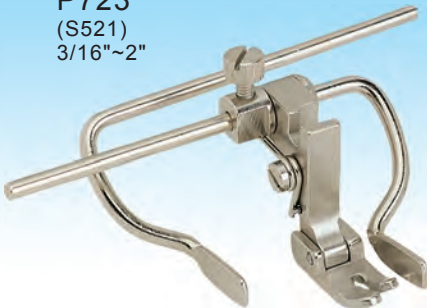

**HINGE FOOT**

**113280  
(113280-0-01)**



150384-0-01

**150789  
(150789-0-01)**



**FOOT FOR COLLARS & BACK BINDINGS**  
**SOLID BLANK FOOT**

**SOLID BLANK FEET**

147308(ART.570)



SP-44



SP-60  
(S402)



SP-61  
(S801)



**SOLID BLANK FEET**

SP-62  
(S802)



SP-63  
(S803)



SP-64  
(S804)



SP-65  
(S400)



**STANDARD FEET**

**QUILTER FEET**

**HINGED PRESSER FEET  
(HEAVY W/GUARD)**

**HINGED PRESSER FEET**

P127  
(127233)



厚物用HEAVY

160342



B1511  
-543-BBA



D-1421-555  
-DOO

特厚物用 MORE HEAVY

B1524  
-522-NBO-A



SIZE  
1/8



## STANDARD HINGED FEET

B1524-012-OAO



B1524-012-BBA



B1524-012-OBO



51742-G  
51742  
(91-051742-03)



SIZE  
1.8mm  
2.2mm

## NYLON RING FOOT

S515  
(CF2-S)

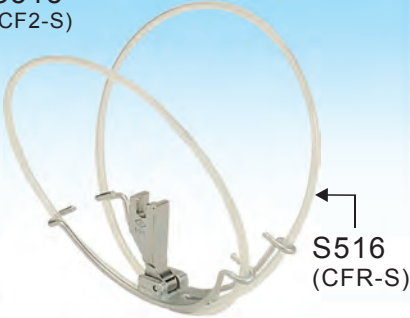

SR-DB-W  
(TRF-1)



## NYLON RING FOOT

SR-DB-R



SR-DB-L





## ROLLER PRESSER FOOT

SDRF



## ROLLER FEET

SPK-3



## ROLLER FEET WITH GUIDE



(RIGHT)  
SIZE  
R-810 1/32  
R-811 1/16  
R-812 1/8  
R-813 3/16  
R-814 1/4  
R-815 5/16

**NEW**



(LEFT)  
SIZE  
R-810L 1/32  
R-811L 1/16  
R-812L 1/8  
R-813L 3/16  
R-814L 1/4  
R-815L 5/16

**NEW**

## ROLLER FEET

R2E



## ROLLER FEET (SPECIAL)

R-3



**NEW**

SIZE  
R-1 LIGHT  
(HM1-1)  
R-2 MEDIUM  
(HM1-2)  
R-3 HEAVY  
(HM1-3)

## ROLLER FEET (SPECIAL)



## ROLLER COMPENSATING FEET (SPECIAL)

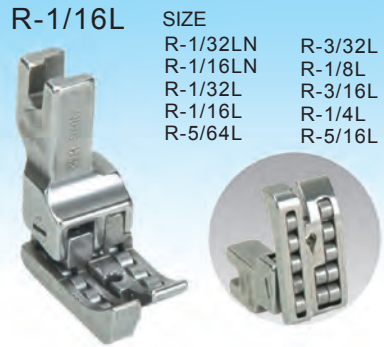
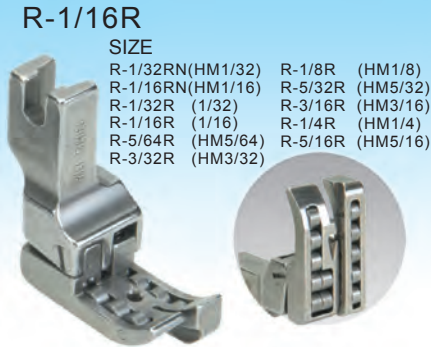

## ROLLER FOOT

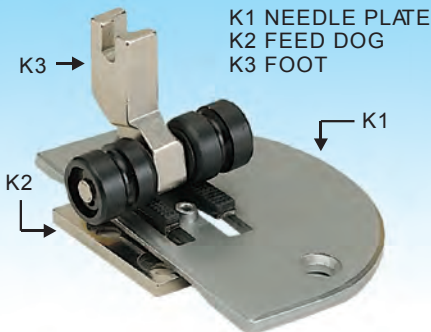

## CHAIN CUT-OFF FEET



## DOMESTIC HEMMER FEET

**H15SH**  
(2858)

SIZE  
2.0mm  
2.5mm  
3.0mm  
4.0mm



## DOMESTIC PIPING FEET

**H15-69HL**

SIZE  
1/8 -3.2mm  
3/16 -4.8mm  
1/4 -6.4mm



## DOMESTIC Z-Z FEET

**H15Z**



## COMPENSATING FEET FOR DOMESTIC MACHINES

**H15**

SIZE  
H10-1.0MM  
H15-1.5MM (ART.1926/1)  
H20-2.0MM  
H25-2.5MM (ART.1926/2)  
H30-3.0MM (ART.1926/3)  
H40-4.0MM (ART.1926/4)  
H50-5.0MM (ART.1926/5)  
H60-6.0MM (ART.1926/6)



## Z/Z DOUBLE COMPENSATING FEET

**H15ZZ**  
(ART. 1929)

SIZE  
3.0MM  
6.0MM



## UNION SPECIAL COMPENSATING FEET

SIZE  
US31 -1/32  
US311 -1/16  
US312 -1/8  
US313 -3/16  
US314 - 1/4



## UNION SPECIAL HINGED FEET

SIZE  
61220J  
61220P  
61320J  
US12435HN  
US12435HW  
US31358HN  
US31358HW  
US40322SH



## MANUL INVISIBLE BLADE FOOT (CUTTER THREAD)

YS-37 (NP-37)

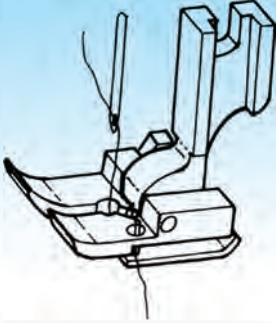

## SPECIAL DESIGN FOOT (CUTTER THREAD)



(W/TAIL)  
368611



(W/O TAIL)  
368607



## TEFLON COMPENSATING FOOT

SIZE(RIGHT)

TCR1/32N(MT210)-B  
TCR1/16N(MT211N)-B  
TCR1/32 (MT21R)-B  
TCR1/16 (MT211)-B  
TCR3/32 (MT2111/2)-B  
TCR1/8 (MT212)-B  
TCR3/16 (MT213)-B  
TCR1/4 (MT214)-B  
TCR5/16 (MT215)-B  
TCR3/8 (MT216)-B  
TCR1/2 (MT218)-B

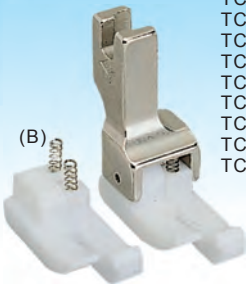

SIZE(LEFT)

TCL1/32N (MT-220)-B  
TCL1/16N (MT-221N)-B  
TCL1/32 (MT22)-B  
TCL1/16 (MT221)-B  
TCL3/32 (MT221 1/2)-B  
TCL1/8 (MT222)-B  
TCL3/16 (MT223)-B  
TCL1/4 (MT224)-B  
TCL5/16 (MT225)-B  
TCL3/8 (MT226)-B  
TCL1/2 (MT228)-B



**TEFLON FOOT**

T350  
T350B



T35  
T35B



T35W  
T35WB



T35C  
T35CB



**TEFLON FOOT**

T35CW  
T35CWB



T363  
T363B



T36N  
T36NB



T36  
T36B



**TEFLON FOOT**

T36LN  
T36LNB



T36L  
T36LB



MT-1  
MT-2

(MT-2)



24983T





## QUILTER & GUIDE FEET

P35G

**NEW**



可以調整左、右擋邊尺寸  
CAN ADJUSTABLE THE SIZE OF  
BOTH SIDE ON THE EGDE

## TEFLON FEET

NT-18

NT-18B



**HINGED FEET  
FOR NEEDLE FEED  
MACHINE**

**(SINGLE NEEDLE)**

PAFF 461 ; 481  
DURKOPP CL.272  
JUKI DLM-522 ALL USED  
(PAGE 24-29)

## NEEDLE FEED COMPENSATING FOOT PFAFFCL.461,481 DURKOPP CL.272



SIZE(RIGHT)

- 210- NF(NARROW-1/32)
- 211N- NF(NARROW-1/16)
- 21R- NF(ART.1649/2-1/32)
- 211- NF(ART.1649/4-1/16)
- 20R- NF(5/64)
- 25R- NF(3/32)
- 212- NF(ART.1649/6-1/8)
- 213- NF(ART.1649/8-3/16)
- 214- NF(ART.1649/10-1/4)
- 215- NF(ART.1649/12-5/16)
- 216- NF(ART.1649/14-3/8)
- 218- NF(ART.1649/16-1/2)



SIZE(LEFT)

- 220- NF(NARROW-1/32)
- 221N- NF(NARROW-1/16)
- 22L- NF(ART.1649/1-1/32)
- 221- NF(ART.1649/3-1/16)
- 20L- NF(5/64)
- 25L- NF(3/32)
- 222- NF(ART.1649/5-1/8)
- 223- NF(ART.1649/7-3/16)
- 224- NF(ART.1649/9-1/4)
- 225- NF(ART.1649/11-5/16)
- 226- NF(ART.1649/13-3/8)
- 228- NF(ART.1649/15-1/2)

## COMPENSATING FEET FOR KNIT

**USE ON THICKNESS OF FABRICS THE SIDE SCREW  
CAN EASY HOLD THE GUIDE ,SO THE CLOTH CAN SMOOTHLY**



SIZE(STRENGTH)

- 210S- NF(NARROW-1/32)
- 211NS- NF(NARROW-1/16)
- 21RS- NF(ART.1649/2-1/32)
- 211S- NF(ART.1649/4-1/16)
- 20RS- NF(5/64)
- 25RS- NF(3/32)
- 212S- NF(ART.1649/6-1/8)
- 213S- NF(ART.1649/8-3/16)
- 214S- NF(ART.1649/10-1/4)
- 215S- NF(ART.1649/12-5/16)
- 216S- NF(ART.1649/14-3/8)
- 218S- NF(ART.1649/16-1/2)



SIZE(STRENGTH)

- 220S- NF(NARROW-1/32)
- 221NS- NF(NARROW-1/16)
- 22LS- NF(ART.1649/1-1/32)
- 221S- NF(ART.1649/3-1/16)
- 20LS- NF(5/64)
- 25LS- NF(3/32)
- 222S- NF(ART.1649/5-1/8)
- 223S- NF(ART.1649/7-3/16)
- 224S- NF(ART.1649/9-1/4)
- 225S- NF(ART.1649/11-5/16)
- 226S- NF(ART.1649/13-3/8)
- 228S- NF(ART.1649/15-1/2)

## NEEDLE FEED W/GUIDE HINGED FEET



SIZE(RIGHT)  
 SP18-NF 1/32 = 1.0mm  
 SP18-NF 1/16 = 1.6mm  
 SP18-NF 3/32 = 2.4mm  
 SP18-NF 1/8 = 3.2mm  
 SP18-NF 3/16 = 4.8mm  
 SP18-NF 1/4 = 6.4mm  
 SP18-NF 5/16 = 8.0mm  
 SP18-NF 3/8 = 9.6mm



SIZE(LEFT)  
 SP18L-NF 1/32 = 1.0mm  
 SP18L-NF 1/16 = 1.6mm  
 SP18L-NF 3/32 = 2.4mm  
 SP18L-NF 1/8 = 3.2mm  
 SP18L-NF 3/16 = 4.8mm  
 SP18L-NF 1/4 = 6.4mm  
 SP18L-NF 5/16 = 8.0mm  
 SP18L-NF 3/8 = 9.6mm



## NEEDLE FEED W/GUIDE HINGED FEET



SIZE(RIGHT)  
 P810-NF 1/32 = 1.0mm  
 P811-NF 1/16 = 1.6mm  
 P812-NF 1/8 = 3.2mm  
 P813-NF 3/16 = 4.8mm  
 P814-NF 1/4 = 6.4mm  
 P815-NF 5/16 = 8.0mm  
 P816-NF 3/8 = 9.6mm



SIZE(LEFT)  
 P820-NF 1/32 = 1.0mm  
 P821-NF 1/16 = 1.6mm  
 P822-NF 1/8 = 3.2mm  
 P823-NF 3/16 = 4.8mm  
 P824-NF 1/4 = 6.4mm  
 P825-NF 5/16 = 8.0mm  
 P826-NF 3/8 = 9.6mm



## NEEDLE FEED PIPING HINGED FEET



SIZE(RIGHT)  
 P69RH-NF 1/8  
 P69RH-NF 3/16  
 P69RH-NF 1/4  
 P69RH-NF 5/16



SIZE(LEFT)  
 P69LH-NF 1/8  
 P69LH-NF 3/16  
 P69LH-NF 1/4  
 P69LH-NF 5/16



## NEEDLE FEED ADJUSTABLE W/GUIDE FEET

G10-NF

**NEW**



- 1. 可以調整左·右擋邊尺寸·
- 2. 車縫布條·可調整大小·0~20mm
- 1. CAN ADJUSTABLE THE SIZE OF BOTH SIDE ON THE EDGE.
- 2. SEAM CLOTH CAN ADJUSTABLE THE TAPE SIZE. 0~20mm

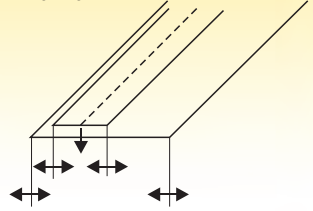

## NEEDLE FEED ADJUSTABLE W/GUIDE FEET





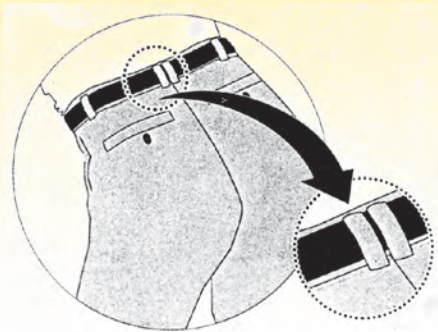



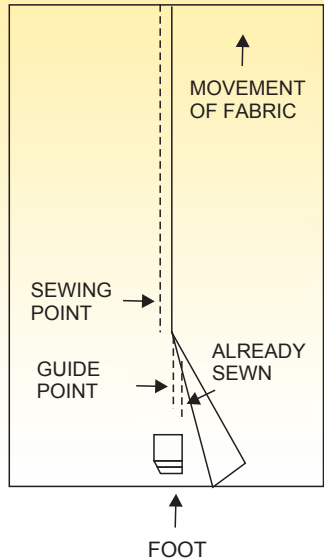



NR31G-NF

NL31G-NF



CONCEALED SEAM FOR SKIRTS OF SLACKS



NEEDLE FEED ZIPPER FEET		NEEDLE FEED ROLLER FEET	NEEDLE FEED W/QULTER GUIDE	
<b>P35G-NF</b>   可以調整左、右擋邊尺寸。 CAN ADJUSTABLE THE SIZE OF BOTH SIDE ON THE EGDE.		<b>R-351-NF</b> 	<b>P723-NF</b>  5~50mm	
NEEDLE FEED ZIPPER FEET				
<b>P363-NF</b> (S363-NF) (ART.1680)  SIZE P363-NF 5.4mm P363W-NF 7.0mm (ART.1688) 5.4mm	<b>P36N-NF</b> (S5000N) (ART.1684)  5.0mm	<b>P36-NF</b> (S8000N) (ART.1690)  8.0mm	<b>P361-NF</b> (S6020N)  8.0mm	
NEEDLE FEED ZIPPER FEET				
<b>P351N-NF</b>   9mm	<b>P36LN-NF</b> (S0050N) (ART.1683)  5.0mm	<b>P36L-NF</b> (S0080) (ART.1689)  8.0mm	<b>P360-NF</b> (S2060N)  8.0mm	

## NEEDLE FEED FEET

**P351-NF**  
(S351NF)



11mm

**P127-NF**  
(ART.6643)



12mm

**P127WK-NF**



14mm

LIGHT  
薄物用

**P127W-NF**  
(ART.6644)



14mm

## NEEDLE FEED FEET

**S518N-NF**  
(ART.1526/1)



**P363VNF**



5.0mm

**P27**  
(S5050N)  
(149027)  
(149085)



**12142AHBNF**



## NEEDLE FEED FEET

**B1524-041-EAO**



**B1524-412-OAO**



**B1524-412-OBO**  
(410916)



**B1524-415-BBA**





## NEEDLE FEED FEET PFAFF CL.461;481 DURKOPPC.L272 JUKIDL.M-522

**P36D-NF**  
(ART.6648)  
DOUBLE



7mm

**S518-NF**  
(ART.1525/1)



**140717-NF**  
(140717-0-01)  
(503541)



**MT1-NF**  
(ART.1602)



MT1-NFB 

## NEED FEED ADJUSTABLE CLOTH GUIDE FOR NECCHI CL.881

**NH-10G**



**NEW**

1. 可以調整左右擋邊尺寸。
2. 車縫布條。可調整大小0~20mm.
1. CAN ADJUSTABLE THE SIZE OF BOTH SIDE ON THE EGDE.
2. SEAM CLOTH CANADJUSTABLE THE TAPE SIZE. 0~20mm

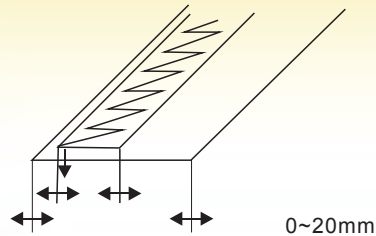

## COMPENSATORE FOOT FOR NECCHI CL.881

(LEFT)  
NH8820 (ART.1626/1-1/32)  
NH8821 (ART.1626/3-1/16)  
NH8821N-1/16(NARROW)



(RIGHT)  
NH8810 (ART.1626/2-1/32)  
NH8811 (ART.1626/4-1/16)  
NH8811N-1/16(NARROW)  
NH8812 (ART.1626/5-1/8)  
NH8813 (ART.1626/6-3/16)  
NH8814 (ART.1626/7-1/4)  
NH8815 (ART.1626/8-5/16)  
Nh8816 (ART.1626/9-3/8)

**NH36LN**(ART.1647)



5.4mm

## PRESSER FEET FOR NECCHI CL.881

**NH36N**  
(ART.1648)



5.4mm

**NH363**  
(ART.1646)



5.4mm

**NH35**  
(ART.1551)  
(961789-3-00)



11mm

**NH351**



11mm

## PRESSER FEET FOR NECCHI CL.881

**NH351W**  
(ART.1522)  
(961761-3-00)



12.7mm

**NH127**



13mm

**NH127W**



14mm

**THE PRODUCTS  
INTRODUCE  
AS BELOW**



ZIG-ZAG HINGED FOOT  
BROTHER 651.652  
SINGER 20U  
PFAFF 48&etc.

## Z-Z MACHINE ADJUSTABLE CLOTH GUIDE FEET









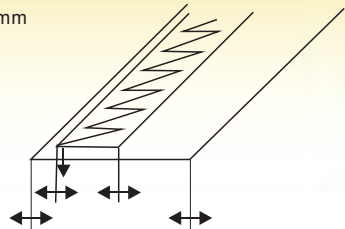

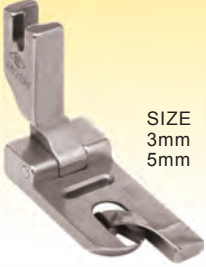
**G10-652**









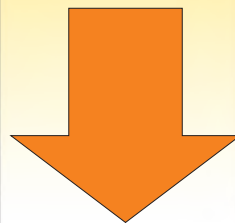

1. 可以調整左、右擋邊尺寸。
2. 車縫布條，可調整大小，0~20mm

1. CAN ADJUSTABLE THE SIZE OF BOTH SIDE ON THE EGDE.
2. SEAM CLOTH CAN ADJUSTABLE THE TAPE SIZE. 0~20mm

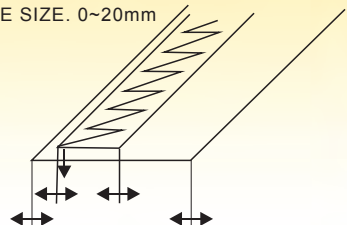

Z-Z ROLLER FEET		Z-Z HEMMER FEET		ZIG-ZAG FEET			
<p><b>R-652</b></p>  <p>SIZE 6mm 12mm</p>		<p><b>652SH</b></p>  <p>SIZE 3mm 5mm</p>		<p><b>652-35</b> (ART.1468)</p>  <p>3mm</p>		<p><b>55112B-G</b> (91-055112)</p>  <p>4.5mm</p>	
ZIG-ZAG FEET			ZIG-ZAG COMPENSATING FEET				
<p><b>54501</b> <b>54501-G</b> (91-054501-03C)</p>  <p>1/4(6.4mm)</p>		<p><b>230ZZ</b></p>  <p>SIZE 3mm (ART.1629/3) 5mm (ART.1629/5)</p>		<p><b>652RZ</b> (ART.1699)</p> 		<p><b>652LZ</b> (ART.1699/1)</p> 	
ZIG-ZAG FOOT							
<p><b>55106</b> <b>55106-G</b> (91-055106CX-10)</p>  <p>10mm</p>		<p><b>541566</b></p>  <p>10mm</p>		<p><b>541781</b></p>  <p>10mm</p>		<p><b>543939</b></p>  <p>12mm</p>	

ZIG-ZAG FOOT			
<p>MT541566</p>  <p>SIZE 5mm 12mm</p> <p>MT541566B</p>	<p>112800-0-01</p>  <p>5mm</p>	<p>111994-0-01</p>  <p>12mm</p>	<p>說明如下 <b>ACCOUNT AS BELOW</b></p> 
PFAFF MACHINE ADJUSTABLE CLOTH GUIDE PFAFF CL.141.138.238			
<p>PF10G</p>  <p><b>NEW</b></p>	<ol style="list-style-type: none"> <li>1.可以調整左、右擋邊尺寸。</li> <li>2.車縫布條,可調整大小, 0~20mm</li> <li>1.CAN ADJUSTABLETHE SIZE OF BOTH SIDEON THE EGDE.</li> <li>2.SEAM CLOTH CANADJUSTABLE THE TAPE SIZE. 0~20mm</li> </ol>		
PFAFF FEET CL.141;138;238			
<p>611P</p>  <p>SIZE(RIGHT) 610NP1/32 (NARROW) 611NP1/16 (NARROW) 611P1/16 612P1/8 613P3/16 614P1/4</p>	<p>621P</p>  <p>SIZE(LEFT) 620NP1/32 (NARROW) 621P1/16</p>	<p>630P(DOUBLE)</p>  <p>SIZE 630P1/32 631P1/16</p>	<p>630ZZ(91-0511863-93)</p>  <p>SIZE 3mm 5mm</p>



## PFAFF FEET CL.141;138;238

**26473**  
(91-026473-05)



**26474**  
(91-026474-05)



**46682**  
(91-046682-03)



**43522A**  
(91-043522-03)



## PRESSER FEET FOR PFAFF CL142;1242;921;925

**54926-1/4**



SIZE  
54926-3/16  
(91-054926-03)  
54926-1/4  
(91-054926-03)  
54926-9/32  
(91-054926-03)

**PF248**



SIZE  
PF248  
30715-3-00mm4.8  
PF260  
961044-3-00mm6.0  
PF264  
961044-3-10mm6.4

**PFG248**



SIZE  
PFG248(1.0mm)  
(ART.1651/1-mm4.8-1.0mm)  
PFG248(2.0mm)  
(ART.1651/1-mm4.8-2.0mm)  
PFG264(1.0mm)  
(ART.1651/2-mm6.4-1.0mm)  
PFG264(2.0mm)  
(ART.1651/2-mm6.4-2.0mm)

**PFR248**



SIZE  
PFR248  
(ART.1628/1-mm4.8)  
PFR264  
(ART.1628/2-mm6.4)

## PRESSER FEET FOR PFAFF CL.142;1242;921;925

**PFD248**



SIZE  
PFD248  
(ART.1639/1-mm4.8)  
PFD264  
(ART.1639/2-mm6.4)

## COPENSATING FEET FOR NECCHI CL.831



(LEFT)  
NH8320 (ART.1625/1 -1/32) (NARROW)  
NH8321 (ART.1625/4 -1/16)  
(RIGHT)  
NH8310 (ART.1625/2 -1/32) (NARROW)  
NH8311N-1/16 (NARROW)  
NH8311 (ART.1625/5 -1/16)  
NH8312 (ART.1625/6 -1/8)  
NH8313 (ART.1625/7 -3/16)  
NH8314 (ART.1625/8 -1/4)  
NH8315 (ART.1625/9 -5/16)  
NH8316 (ART.1625/10 -3/8)



## HINGED FEET FOR NEEDLE FEED MACHINE CL.831

**NH8331D-1/16**

DOUBLE  
NH8330D-1/32  
(ART.1625/3-1/32)  
NH8831D-1/16  
(ART.1625/3-1/16)



**NH363-1**  
(ART.1643)



5.4mm

**NH36N-1**  
(ART.1642)



5.4mm

**NH36LN-1**  
(ART.1641)



5.4mm

## HINGED FEET FOR NEEDLE FEED MACHINE CL.831

**CL831-NF1**  
(ART.1615)

底部  
CL831-NFB  
(ART.1612/1)



**NH36-1**



7mm

**NH36L-1**



7mm

## PFAFF CL.442

**PF264-1**

SIZE  
PF248-1  
(ART.1694/1 4.8mm)  
PF264-1  
(ART.1694/2 6.4mm)



## PRESSER FOOT FOR PFAFF CL.442

**PFG264-2R**

SIZE  
PFG248-1R  
(ART.1695/1 4.8mm)  
PFG248-2R  
(ART.1695/2 4.8mm)  
PFG264-1R  
(ART.1696/1 6.4mm)  
PFG264-2R  
(ART.1696/2 6.4mm)



**PFG264-2L**

SIZE  
PFG248-1L  
(ART.1557/1 4.8mm)  
PFG248-2L  
(ART.1557/2 4.8mm)  
PFG264-1L  
(ART.1558/1 6.4mm)  
PFG264-2L  
(ART.1558/2 6.4mm)



## PRESSER FOOT FOR NECCHI CL.971;974;976

### NH264N

SIZE  
NH248N  
(ART.1698/1 4.8mm)  
NH264N  
(ART.1698/2 6.4mm)



### NH264H

SIZE  
NH248H  
(ART.6645/1 4.8mm)  
NH264H  
(ART.6645/2 6.4mm)  
(HEAVY MATERIALS)



### NH264

SIZE  
NH248  
(ART.1623/1 4.8mm)  
(961799-3-00)  
NH260  
(ART.1623/2 6.0mm)  
(961773-3-00)  
Nh264  
(ART.1623/3 6.4mm)  
(961773-3-10)



### NHG264H

SIZE  
NHG248H  
(ART.6646/1 4.8mm)  
NHG264H  
(ART.6646/2 6.4mm)  
(HEAVY MATERIALS)



## PRESSER FOOT FOR NECCHI CL.971;974;976

### NHG264-2R

SIZE  
NHG248-2R  
(ART.1652/1 4.8mm)  
NHG264-2R  
(ART.1652/2 6.4mm)



### NHR264

SIZE  
NHR248  
(ART.1627/1 4.8mm)  
NHR264  
(ART.1627/2 6.4mm)



### NHD264

DOUBLE  
NHD248  
(ART.1679/1 4.8mm)  
NHD264  
(ART.1679/2 6.4mm)



THE PRODUCTS  
INTRODUCE  
AS BELOW

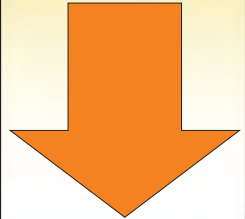

## ADJUSTABLE CLOTH GUIDE FOR DURKOPP MACHINE DURKOPP CL.212

### DK-10G

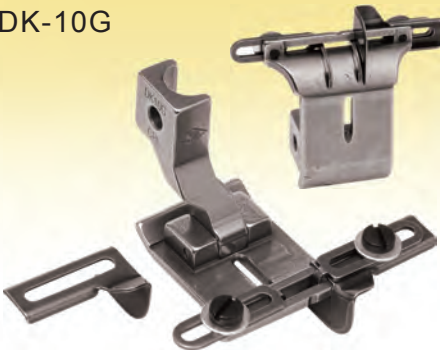

1. 可以調整左、右擋邊尺寸。
2. 車縫布條，可調整大小。0~20mm
1. CAN ADJUSTABLE THE SIZE OF BOTH SIDE ON THE EDGE.
2. SEAM CLOTH CAN ADJUSTABLE THE TAPE SIZE. 0~20mm

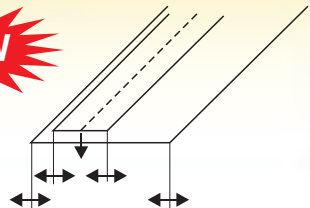

**PRESSER FOOT FOR DURKOPP**

**CL-212**

**DKMT-1**  
(ART.1603)

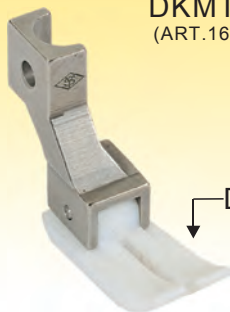

DKMT-1B



**DK36D**  
(ART.6647)

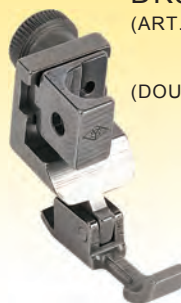

(DOUBLE)

**DK518N**



**DK518**



**Dk363**  
(ART.1623)



**DK363W**  
(ART.1685)



**DK36N**  
(ART.1682)



**DK36**  
(ART.1687)



**DK36LN**  
(ART.1681)



**DK36L**  
(ART.1686)



## PRESSER FEET FOR DUOPP CL-212



**DK211** DK211R (ART.1620/2 -1/32)  
 DK211 (ART.1620/4 -1/16)  
 DK212 (ART.1620/6 -1/8)  
 DK213 (ART.1620/8 -3/16)  
 DK214 (ART.1620/10-1/4)  
 DK215 (ART.1620/12-5/16)  
 DK216 (ART.1620/14-3/8)  
 DK218 (ART.1620/16-1/2)



**DK221** DK22L (ART.1620/1 -1/32)  
 DK221 (ART.1620/3 -1/16)  
 DK222 (ART.1620/5 -1/8)  
 DK223 (ART.1620/7 -3/16)  
 DK224 (ART.1620/9 -1/4)  
 DK225 (ART.1620/11- 5/16)  
 DK226 (ART.1620/13- 3/8)  
 DK228 (ART.1620/15- 1/2)



**DK351**  
 (212-1193)  
 (ART.1309)

7/16



**DK127**  
 (212-903)  
 (ART.6650)

33/64



**DK127W**  
 (212-1643)  
 (ART.1289)

35/64



**DK127WK**  
 (212-887)  
 (ART.1285)

35/64



## DURKOPP W/GUIDE HINGED FEET

CL.212

DK821-1/16



SIZE  
 DK-820-1/32  
 DK-821-1/16  
 DK-822-1/8  
 DK-823-3/16  
 DK-824-1/4  
 DK-825-5/16



DK811-1/16



SIZE  
 DK-810-1/32  
 DK-811-1/16  
 DK-812-1/8  
 DK-813-3/16  
 DK-814-1/4  
 DK-815-5/16



## BRASSIERE FOOT W/GUIDE (THE CLOTH EASY PASS THROUGH)

SIZE(RIGHT)  
 針距-邊距  
 (NEEDLE)-(EDGE)  
 S570S- 1/8 -1/32  
 S570S- 3/16 -1/32  
 S570S- 1/4 -1/32  
 S570S- 5/16 -1/32  
 S570S- 3/8 -1/32  
 S570S- 1/2 -1/32



SIZE(LEFT)  
 針距-邊距  
 (NEEDLE)-(EDGE)  
 S570SL- 1/8 -1/32  
 S570SL- 3/16 -1/32  
 S570SL- 1/4 -1/32  
 S570SL- 5/16 -1/32  
 S570SL- 3/8 -1/32  
 S570SL- 1/2 -1/32

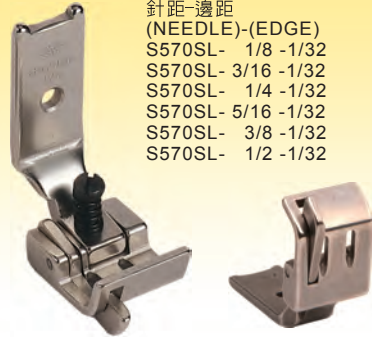

## BRASSIERE FOOT W/GUIDE (THE CLOTH EASY PASS THROUGH)

SIZE(RIGHT)  
 針距-邊距  
 (NEEDLE)-(EDGE)  
 S570S- 1/8-1/16  
 S570S-3/16-1/16  
 S570S- 1/4-1/16  
 S570S-5/16-1/16  
 S570S- 3/8-1/16  
 S570S- 1/2-1/16



SIZE(LEFT)  
 針距-邊距  
 (NEEDLE)-(EDGE)  
 S570SL- 1/8-1/16  
 S570SL-3/16-1/16  
 S570SL- 1/4-1/16  
 S570SL-5/16-1/16  
 S570SL- 3/8-1/16  
 S570SL- 1/2-1/16

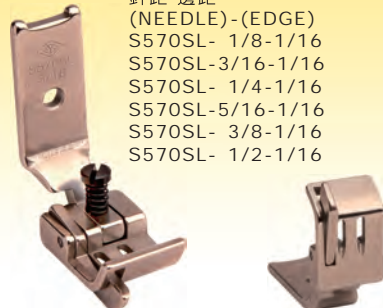



## BRASSIERE FOOT W/GUIDE (THE CLOTH EASY PASS THROUGH)



**S570SD-1/4-1/32**  
 SIZE(DOUBLE)  
 針距-邊距  
 (NEEDLE)-(EDGE)  
 S570SD-1/8 -1/32  
 S570SD-3/16-1/32  
 S570SD-1/4 -1/32



**S570SD-1/4-1/16**  
 SIZE(DOUBLE)  
 針距-邊距  
 (NEEDLE)-(EDGE)  
 S570SD-1/8 -1/16  
 S570SD-3/16-1/16  
 S570SD-1/4 -1/16



## DOUBLE NEEDLE ADJUSTABLE EXTRA CLOTH GUIDE FEET

**S570-A25**

SIZE  
 S570-A25 1/8  
 S570-A25 3/16  
 S570-A25 1/4  
 S570-A25 5/16  
 調整式 5mm~50mm

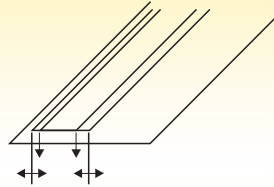

## DOUBLE NEEDLE ADJUSTABLE CLOTH GUIDE FEET

**G10-570**

SIZE  
 G10-570 1/8  
 G10-570 3/16  
 G10-570 1/4  
 G10-570 5/16  
 G10-570 3/8

SIZE  
 1.可以調整左.右擋邊尺寸  
 2.車縫布條.可調整大小. 0~20mm  
 1.CAN ADJUSTABLE THE SIZE  
 OF BOTH SIDE ON THE EGDE  
 2.SEAM CLOTH CANADJUSTABLE  
 THE TAPE SIZE. 0~20mm

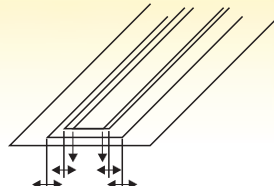
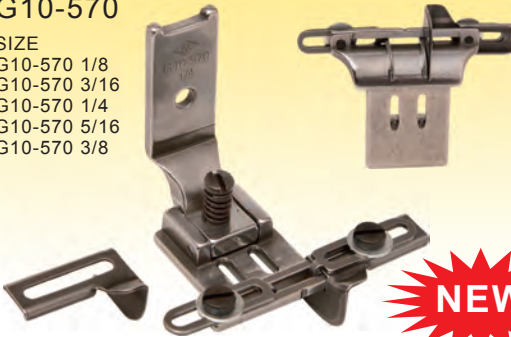

## DOUBLE NEEDLE WITH REMOVABLE GUIDE FEET



可以調整左.右擋邊尺寸  
CAN ADJUSTABLE THE SIZE  
OF BOTH SIDE ON THE EDGE

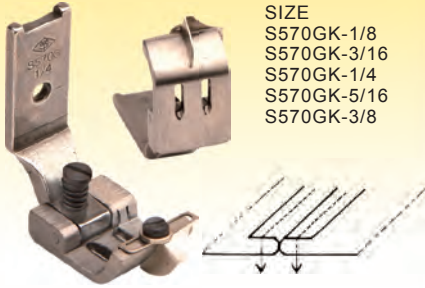

SIZE  
S570GK-1/8  
S570GK-3/16  
S570GK-1/4  
S570GK-5/16  
S570GK-3/8

## DOUBLE ROLLER FOOT

SIZE  
(NEEDLE)-(OUTER WIDTH)  
R-232-1/8 (HM7-1 1/8)  
R-248-3/16 (HM7-1 3/16)  
R-264-1/4 (HM7-1 1/4)  
R-280-5/16 (HM7-1 5/16)  
R-295-3/8 (HM7-1 3/8)



## ZIG-ZAG MACHINE EDGE GUIDE ADJUSTABLE FEET

G10-457

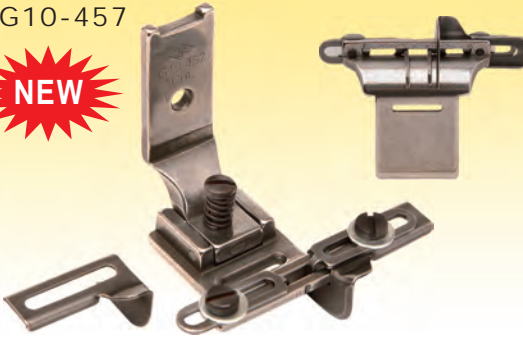

1. 可以調整左.右擋邊尺寸.  
2. 車縫布條. 可調整大小 0~20mm.  
1. CAN ADJUSTABLE THE SIZE OF  
BOTH SIDE ON THE EDGE.  
2. SEAM CLOTH CAN ADJUSTABLE  
THE TAPE SIZE. 0~20mm

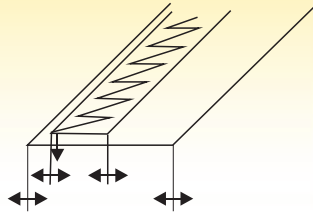

## ZIG-ZAG MACHINE ADJUSTABLE EXTRA SIZE FEET



107-A25



5mm~50mm

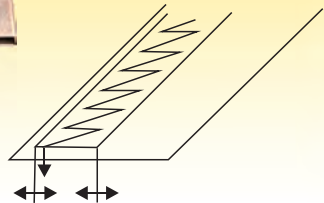

SINGER 457G; 457U; 107W ZIG-ZAG ADJUSTABLE FOOT

S457AT  
(503896)



車縫布條.可調整大小  
SEAM CLOTH CAN  
ADJUSTABLE THE  
TAPE SIZE  
5mm~20mm

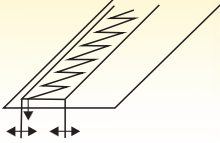

SINGER 457G; 457U; 107W ZIG-ZAG ADJUSTABLE FOOT

S457AT-G  
(503896-G)



車縫布條.可調整大小  
SEAM CLOTH CAN  
ADJUSTABLE THE  
TAPE SIZE  
5mm~20mm

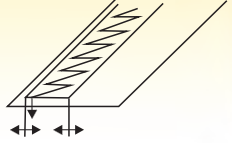

SINGER 457G; 457U; 107W ZZ REMOVE FEET

107GK



可以調整左.右擋邊尺寸  
CAN ADJUSTABLE THE  
SIZE OF BOTH SIDE ON  
THE EGDE

ZIG-ZAG ELASTIC FEET



107CA  
(23771S)

SIZE  
107CA-6mm  
107CA-8mm  
107CA-10mm  
107CA-12mm

ZIG-ZAG ROLLER FOOT

SIZE (針孔寬-外徑寬)  
NEEDLE SIZE - OUTER WIDTH  
R-457-1 7.5 -17.5(HM4-5)  
R-457-2 10.5 -20.5(HM4-7)  
R-457-3 12.5 -22.5  
R-457-4 15 -23.5(HM4-3)



ZIG-ZAG TEFLON COATED FEET

(針孔寬-外徑寬)  
NEEDLE SIZE - OUTER WIDTH  
CF457-1 5.0 -10  
CF457-2 7.5 -12  
CF457-3 7.5 -14  
CF457-4 10.5 -16  
CF457-5 12.5 -19  
CF457-6 14.5 -22.5



## ZIG-ZAG PRESSER FOOT For 107W;457G;457U etc.

411314



503660



503736



THE THREAD ENTER  
THE GROOVE ON  
THE FRONT SECTION

SIZE- 針孔寬  
(NEEDLE HOLE WIDTH)  
411314-1 6.5mm  
411314-2 7.5mm  
411314-3 10.5mm  
411314-4 12.5mm  
411314-5 14.5mm



## ZIG-ZAG PRESSER FOOT For 107W;457G;457U etc.

23705  
(266125)



241414



107CR



107CL



## COMPENSATING FEET FOR 107W;457G;457U

PF-A1R



RIGHT  
PF-A1R

PF-A1L



LEFT  
PF-A1L

521ZR



521ZL





## ZIG-HEMMER FOOT

457SH-2.0mm  
457SH-2.5mm  
457SH-3.0mm  
457SH-4.0mm  
457SH-5.0mm



## ZIG-PRESSER FOOT SINGER 111W; 211W FEET

P375  
(241375)



3mm

P375BL



3mm

P882  
(229882)



## ZIG-ZAG EDGE GUIDE FEET For 107W;457G;457U

107SGR-2



107SGL-2



## ZIG-ZAG EDGE GUIDE FEET FOR 107W;457U;457G

107SGR-4



107SGL-4





## ZIG-ZAG BINDER FEET

210562A2



210564A4



## ZIG-ZAG BRASSIRE FOOT

適用直線(LONG BOTTOM) 外寬-針孔寬  
OUTER WIDTH-NEEDLESINE



SIZE  
457-01X10.2mm -6.2mm  
457-02X12 mm -7.5mm  
457-03X14 mm -7.5mm  
457-04X16 mm -10.5mm  
457-05X19 mm -12.5mm  
457-06X22 mm -14.5mm

適用轉角(SHORT BOTTOM) 外寬-針孔寬  
OUTER WIDTH-NEEDLESINE



SIZE  
457-1X10.2mm-6.2mm  
457-2X12 mm-7.5mm  
457-3X14 mm-7.5mm  
457-4X16 mm-10.5mm  
457-5X19 mm-12.5mm  
457-6X22 mm-14.5mm

## INVISIBLE CUTTER THREAD FEET

282140

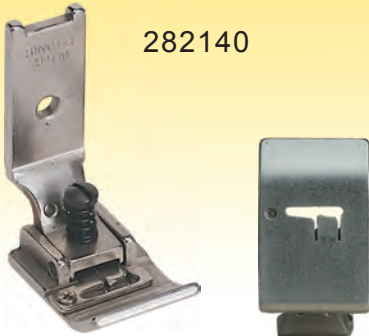

282139



## ZIG-ZAG THICKER MATERIAL FEET

503595  
503595-G

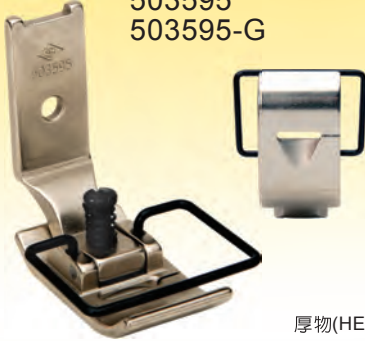

厚物(HEAVY)

## ZIG-ZAG LIGHT MATERIAL FEET

503595HK  
503595HK-G



薄物(LIGHT)

## ZIG-ZAG THICKER MATERIAL FEET

503689  
503689-G



厚物(HEAVY)

## ZIG-ZAG LIGHT MATERIAL FEET

503689HK  
503689HK-G



薄物(LIGHT)

## ZIG-ZAG STANDARD FEET

411215  
411215-G

標準押布腳  
STANDARD FEET



## ZIG-ZAG STANDARD FEET

503818  
503818-G

標準押布腳  
STANDARD FEET



<p><b>SINGLE NEEDLE FOR ALL MACHINE</b></p> <p><b>150384-0-01</b></p> <p>可加裝在各廠牌單針安全保護套 THE SAFETY GUARD USE ON ALL KIND OF MACHINE FOR SINGLE NEEDLE.</p> <p>150384-0-01 → </p>	<p><b>FOR SINGER SINGLE NEEDLE MACHINES</b></p> <p>Classes:95;96;400W; 600w;31-15;241;251 ETC. NEEDLE GUARD #G5</p> 	<p><b>FOR PFAFF Classes: 461;462;463;467;469; 483;434;ETC.</b></p> <p><b>NEEDLE GUARD #19S(#61231A)</b></p> 	
<p><b>FOR SINGER Classes: 112W;212W;ETC.</b></p> <p><b>NEEDLE GUARD #14R</b></p> 	<p><b>FOR SINGER Classes: 107W;111W;143W;153K; 153W;457G;ETC.</b> SINGLE NEEDLE MACHINE</p> <p><b>NEEDLE GUARD #259081 (#225365)</b></p> 	<p><b>FOR WW DOUBLE NEEDLE MACHINES</b></p> <p><b>NEEDLE GUARD #22G</b></p> 	<p><b>FOR SINGER Classes: 108W AND WW SINGLE NEEDLE MACHINE</b></p> <p><b>NEEDLE BUARD #16A</b></p> 
<p><b>3 NEEDLE EDGE GUIDE WITH ROLLER ADJUSTABLE FEET</b></p> <p><b>R-3DW-G10</b></p> <p>1. 可以調整左、右擋邊尺寸。 2. 車縫布條，可調整大小。 0~20mm</p> <p>1.CAN ADJUSTABLE THE SIZE OF BOTH SIDE ON THE EGDE. 2.SEAM CLOTH CAN ADJUSTABLE</p> <p>THE TAPE SIZE. 0~20mm</p> <p><b>NEW</b></p>  <p>SIZE 4.8mm 5.6mm 6.4mm</p>		<p><b>3 NEEDLE EDGE GUIDE WITH ROLLER FEET</b></p> <p><b>R-3DWG</b></p> <p>可以調整左、右擋邊尺寸 CAN ADJUSTABLE THE SIZE OF BOTH SIDE ON THE EGDE.</p> <p>SIZE 4.8mm 5.6mm 6.4mm</p> <p><b>NEW</b></p> 	<p><b>3 NEEDLE TEFLON COATED FOOT</b></p> <p><b>CF3DW</b></p> <p>SIZE 4.8mm 5.6mm 6.4mm</p> 

**3 STITCHING OVERLOCKED SEAM  
FOR BROTHER PEGASUS SIRUBA**

R3-1(HM6-1-1)



THE DRAWING FOR REFERENCE ONLY, IT BASE ON DIFFERENT OF FEET. (僅供參考, 以實物為準)

**4 STITCHING OVERLOCKED SEAM  
FOR YAMATO PEGASUS JUKI**

R4-2 (HM6-1-4)

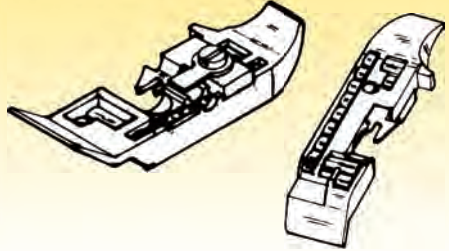

THE DRAWING FOR REFERENCE ONLY, IT BASE ON DIFFERENT OF FEET. (僅供參考, 以實物為準)

**3 STITCHING OVERLOCKED SEAM  
FOR YAMATO SIRUBA JUKI PEGASUS**

R3-2(HM6-1-3)

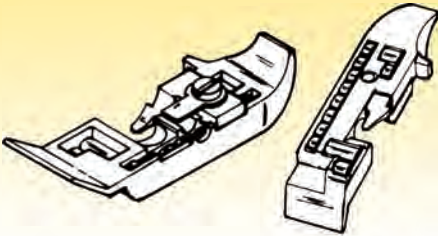

THE DRAWING FOR REFERENCE ONLY, IT BASE ON DIFFERENT OF FEET. (僅供參考, 以實物為準)

**5 STITCHING OVERLOCKED SEAM  
FOR PEGASUS SIRUBA**

R5-1X 3mm(HM6-2-1X 3mm)  
R5-1X 5mm(HM6-2-1X 5mm)



THE DRAWING FOR REFERENCE ONLY, IT BASE ON DIFFERENT OF FEET. (僅供參考, 以實物為準)

**4 STITCHING OVERLOCKED SEAM  
FOR BROTHER PEGASUS SIRUBA**

R4-1(HM6-1-2)



THE DRAWING FOR REFERENCE ONLY, IT BASE ON DIFFERENT OF FEET. (僅供參考, 以實物為準)

**5 STITCHING OVERLOCKED SEAM  
FOR JUKI KINTEX**

R5-2X 3mm(HM6-2-2X 3mm)  
R5-2X 5mm(HM6-2-2X 5mm)

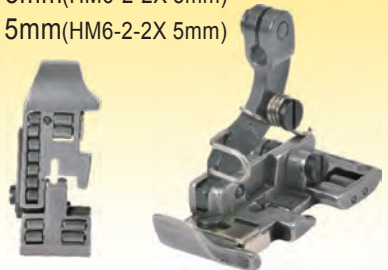

THE DRAWING FOR REFERENCE ONLY, IT BASE ON DIFFERENT OF FEET. (僅供參考, 以實物為準)

## TURRET TO TAKE 3 PRESSER FEET

154628-0-01 (FOR BROTHER)



(PRESSER FOOT NOT INCLUDED)

MAS-07300-AAO  
(FOR JUKI)



#SS1  
#PB-3  
#NBBF

SCREW/SPRING ITEM NO	LENGTH	APPURTENANCE SUITABLE FOR LENGTH 適用 配件 / 尺寸 表	UNIT PRICE NT\$
CFS-1	13.5mm	CR/CL1/32E(K), CR/CL1/16E(K), CR/CL3/32E(K), CR/CL10, CR/CL15, CR/CL20, CR/CL25, 21R, 211R, 22L, 221, 211 1/2, 221 1/2.	3
CFS-2	14.5mm	CR/CL1/8E(K), CR/CL30, 212, 222.	3
CFS-3	16mm	CR/CL3/16E(K), CD0.8/1.0mm, 213, 223, 231.	3
CFS-4	17.5mm	CR/CL1/4E(K), CD-20, CR/CL65, CR/CL70, 214, 224	3
CFS-5	10.5mm	CR/CL1/32N(K), CR/CL1/16N(K), CR/CL10N, CR/CL15N, 210, 211N, 220, 221N.	3
CFS-6	20.5mm	CR/CL3/8E(K) CR/CL90, CR/CL95, CR/CL100, 216, 226, 21-16.	3
CFS-7	19mm	CR/CL5/16E(K), CR/CL80, 215, 225	3
CFS-8	21.5mm	CD-30, D232.	3
CFS-9	18mm	211-14.	3
CFS-10	3mmx0.5	21-14~211-18 (內角螺絲)	3
CFS-11	19.5mm	211-14, 21-14	3
CFS-12	19.5mm		3
CFS-13	24mm	CR/CL1/2E(K), 21-18, D233.	3
CFS-14	25mm	D234	3
CSP-1	2.5x8mm	CR/CL1/32N(K), CR/CL1/16N(K), (B20)	0.5
CSP-2	2.8x8mm	CR/CL1/32E(K), CR/CL1/2E(K), (B25)	0.5
CSP-4	2.0x8.5mm	211-14, 211-18	0.5
CSP-5	3.0x8mm	21R~218, 22L~228 , T36N, T36LN, T363 (B30U)	0.5



## CONVERSION TABLE INCH / MILLIMETER

(吋) INCH	(mm) MILLIMETER	(吋) INCH	(mm) MILLIMETER	(吋) INCH	(mm) MILLIMETER
1/64"	0.40mm	25/64"	9.92mm	29/32"	23.02mm
1/32"	0.79mm	13/32"	10.32mm	15/16"	23.81mm
3/64"	1.19mm	27/64"	10.72mm	31/32"	24.61mm
1/16"	1.59mm	7/16"	1.11mm	63/64"	25.00mm
5/64"	1.98mm	29/64"	11.51mm	1"	25.40mm
3/32"	2.38mm	15/32"	11.91mm	1-1/8"	28.58mm
7/64"	2.78mm	31/64"	12.30mm	1-1/4"	31.75mm
1/8"	3.18mm	1/2"	12.70mm	1-3/8"	34.93mm
9/64"	3.57mm	33/64"	13.10mm	1-1/2"	38.10mm
5/32"	3.97mm	17/32"	13.49mm	1-3/4"	44.45mm
11/64"	4.37mm	35/64"	13.89mm	2"	50.80mm
3/16"	4.76mm	9/16"	14.29mm	2-1/4"	57.15mm
13/64"	5.16mm	37/64"	14.68mm	2-1/2"	63.50mm
7/32"	5.56mm	19/32"	15.08mm	2-3/4"	69.85mm
15/64"	5.95mm	39/64"	15.48mm	3"	76.20mm
1/4"	6.35mm	5/8"	15.88mm	3-1/4"	82.55mm
17/64"	6.75mm	21/32"	16.67mm	3-1/2"	88.90mm
9/32"	7.14mm	11/16"	17.46mm	3-3/4"	95.25mm
19/64"	7.54mm	23/32"	18.26mm	4"	101.60mm
5/16"	7.94mm	3/4"	19.05mm	4-1/4"	107.95mm
21/64"	8.33mm	25/32"	19.84mm	4-1/2"	114.30mm
11/32"	8.73mm	13/16"	20.64mm	4-3/4"	120.65mm
23/64"	9.13mm	27/32"	21.43mm	5"	127.00mm
3/8"	9.53mm	7/8"	22.23mm	6"	152.40mm

02 (1/8).....	11	210-NF (NARROW-1/32).....	24	225S-NF (ART.1649/11-5/16).....	24
04 (3/16).....	11	210S-NF (NARROW-1/32).....	24	226-NF (ART.1649/16-3/8).....	24
06 (1/4).....	11	211-13 (1/16x3/16).....	4	226S-NF (ART.1649/13-3/8).....	24
1 (160344-1/16).....	11	211-14 (1/16x1/4).....	4	228-NF (ART.1649/15-1/2).....	24
1 1/2 (120-802-1 1/2).....	11	211-15 (1/16x5/16).....	4	228S-NF (ART.1649/15-1/2).....	24
107-A25 (5~50mm).....	40	211-16 (1/16x3/8).....	4	22G.....	46
107CA-10MM(23771S).....	41	211-18 (1/16x1/2).....	4	22L-NF (ART.1649/1-1/32).....	24
107CA-12MM(23771S).....	41	21-13 (1/32x3/16).....	4	22LS-NF (ART.1649/1-1/32).....	24
107CA-6MM (23771S).....	41	21-14 (1/32x1/4).....	4	230ZZ3mm(ART.1629/3).....	31
107CA-8MM (23771S).....	41	21-15 (1/32x5/16).....	4	230ZZ5mm(ART.1629/5).....	31
107CL.....	42	21-16 (1/32x3/8).....	4	231-13-23 (1/16-3/16-3/16).....	4
107CR.....	42	21-18 (1/32x1/2).....	4	231-14-24 (1/16-1/4-1/4).....	4
107GK (外徑19MM~12MM針孔寬).....	41	211-NF (ART.1649/4-1/16).....	24	231-15-25 (1/16-5/16-5/16).....	4
107SGL-2.....	43	211N-NF (NARROW-1/16).....	24	23-13-23 (1/32-3/16-3/16).....	4
107SGL-4.....	43	211NS-NF(NARROW-1/16).....	24	23-14-24 (1/32-1/4-1/4).....	4
107SGR-2.....	43	211S-NF (ART.1649/4-1/16).....	24	23-15-25 (1/32-5/16-5/16).....	4
107SGR-4.....	43	212-NF (ART.1649/6-1/8).....	24	23705 (266125).....	42
111994-0-01-12MM(652-12mm).....	32	212S-NF (ART.1649/6-1/8).....	24	241414.....	42
112800-0-01-5MM(652-5mm).....	32	213-NF (ART.1649/8-3/16).....	24	24983T.....	23
113280(113280-0-01).....	16	213S-NF (ART.1649/8-3/16).....	24	259081 (225365).....	46
12142AHB.....	10	214-NF (ART.1649/10-1/4).....	24	25L-NF (3/32).....	24
12142AHBNF.....	28	214S-NF (ART.1649/10-1/4).....	24	25LS-NF (3 /32).....	24
140717-NF(140717).....	29	215-NF (ART.1649/12-5/16).....	24	25R-NF (3/32).....	24
147308 (ART.570).....	17	215S-NF (ART.1649/12-5/16).....	24	25RS-NF (3 /32).....	24
14R.....	46	216-NF (ART.1649/14-3/8).....	24	26473 (91-026473-05).....	33
150384-0-01.....	46	216S-NF (ART.1649/14-3/8).....	24	26474 (91-026474-05).....	33
150789 (150789-0-01).....	16	218-NF (ART.1649/16-1/2).....	24	26650DG-1/8.....	9
154628-0-01.....	48	218S-NF (ART.1649/16-1/2).....	24	26650L-1/8.....	8
160342.....	17	21R-NF (ART.1649/2-1/32).....	24	26650R-1/8.....	8
16-32 (1/16-1/8).....	4	21RS-NF (ART.1649/2-1/32).....	24	282139.....	44
16-48 (1/16-3/16).....	4	220-NF (NARROW-1/32).....	24	282140.....	44
16-64 (1/16-1/4).....	4	220S-NF (NARROW-1/32).....	24	2CJ1 (NP-63P-2)(尖).....	14
16-80 (1/16-5/16).....	4	221-NF (ART.1649/3-1/16).....	24	3 (120804-5/32).....	11
16A (490607).....	46	221N-NF (NARROW-1/16).....	24	368607.....	22
19S (61231A).....	46	221NS-NF(NARROW-1/16).....	24	368611.....	22
2 (120938-3/32).....	11	221S-NF (ART.1649/3-1/16).....	24	3CJ1 (NP-63P-1)(平).....	14
2 1/2 (120938-1/8).....	11	222-NF (ART.1649/5-1/8).....	24	4 (120805-3/16).....	11
20L-NF (5/64).....	24	222S-NF (ART.1649/5-1/8).....	24	411215 (標準型).....	45
20LS-NF(5/64).....	24	223-NF (ART.1649/7-3/16).....	24	411215-G (標準型).....	45
20R-NF (5/64).....	24	223S-NF (ART.1649/7-3/16).....	24	411314 (標準型).....	42
20RS-NF(5/64).....	24	224-NF (ART.1649/9-1/4).....	24	411314-1X 6.5mm(針孔寬).....	42
210562A2.....	44	224S-NF (ART.1649/9-1/4).....	24	411314-2X 7.5mm(針孔寬).....	42
210564A4.....	44	225-NF (ART.1649/11-5/16).....	24	411314-3X10.5mm(針孔寬).....	42

411314-4X12.5mm(針孔寬).....42	543939 12mm.....31	A227-1/4 (S537-1/4).....11
411314-5X14.5mm(針孔寬).....42	54501 (91-054501-03C)....31	A227-1/8 (S537-1/8).....11
43522A(91-043522-03).....33	54501-G (91-054501-03C)....31	A227-3/16 (S537-3/16).....11
457-01(適用直行)(10.2- 6.2).....44	54926-G 1/4 (91-054926-03)..33	A227-3/8 (S537-3/8).....11
457-02(適用直行)(12 - 7.5).....44	54926-G 3/16(91-054926-03).33	A227-5/16 (S537-5/16).....11
457-03(適用直行)(14 - 7.5).....44	54926-G 9/32(91-054926-03).33	B1511-543-BBA.....17
457-04(適用直行)(16 -10.5).....44	55106CX-10mm(91-055106-23/006). 31	B1524-012-BBA .....18
457-05(適用直行)(19 -12.5).....44	55112B-G-4.5mm(91-055112-23/002).31	B1524-012-OAO.....18
457-06(適用直行)(22 -14.5).....44	5G.....46	B1524-012-OBO.....18
457-1(適用轉角)(10.2- 6.2).....44	6 (120806-1/4).....11	B1524-012-OOC.....18
457-2(適用轉角)(12 - 7.5).....44	610NP (1/32-NARROW).....32	B1524-041-EAO.....28
457-3(適用轉角)(14 - 7.5).....44	611NP (1/16-NARROW).....32	B1524-412-OAO.....28
457-4(適用轉角)(16 -10.5).....44	611P (1/16-RIGHT).....32	B1524-412-OBO(410916).....28
457-5(適用轉角)(19 -12.5).....44	61220J.....21	B1524-415-BBA .....28
457-6(適用轉角)(22 -14.5).....44	61220P.....21	B1524-522-NBO-A-1/8.....17
457SH-2.0mm(人字車三卷押腳)....43	612P (1/8-RIGHT).....32	CB 1 1/4 (604).....10
457SH-2.5mm(人字車三卷押腳)....43	61320J.....21	CB 1 1/8 (603).....10
457SH-3.0mm(人字車三卷押腳)....43	613P (3/16-RIGHT).....32	CB 1" (602).....10
457SH-4.0mm(人字車三卷押腳)....43	614P (1/4-RIGHT).....32	CB 3/4 (601).....10
457SH-5.0mm(人字車三卷押腳)....43	620NP (1/32-NARROW).....32	CD-00 (23).....4
46682(91-046682-03).....33	621P (1/16-LEFT).....32	CD-1/16 (D231).....4
5(120940-7/32).....11	630P (1/32-DOUBLE).....32	CD-1/32 (D23).....4
503595厚物(HEAVY).....45	630ZZ-3mm(91-0511863-93).32	CD-1/4 (D234)(CD-64).....4
503595-G厚物(HEAVY).....45	630ZZ-5mm(91-0511863-93).32	CD-1/8 (D232)(CD-32).....4
503595HK薄物(LIGHT).....45	631P (1/16-DOUBLE).....32	CD-10 (1.0mm).....4
503595HK-G薄物(LIGHT).....45	652-35 (ART.1468).....31	CD-15 (1.5mm).....4
503660.....42	652LZ (ART.1699/1).....31	CD-20 (2.0mm).....4
503689厚物(HEAVY).....45	652RZ (ART.1699).....31	CD-3/16 (D233).....4
503689-G厚物(HEAVY).....45	652SH-3mm.....31	CDN-00 (230).....4
503689HK薄物(LIGHT).....45	652SH-5mm.....31	CDN-1/32 (D23N).....4
503689HK-G薄物(LIGHT).....45	8-32 (1/32-1/8).....4	CDN-1/6 (D231N).....4
503736.....42	8-48 (1/32-3/16).....4	CF351 11mm.....7
503818(標準型).....45	8-64 (1/32-1/4).....4	CF35 11mm.....7
503818-G(標準型).....45	8-80 (1/32-5/16).....4	CF351W 12.7mm.....7
51742-1.8mm.....18	990474-0-01.....4	CF360 8mm.....7
51742-2.2mm(91-051742-03).....18	A10-01-1 1/2 (12142C-1 1/2)....9	CF361 8mm.....7
51742-G(1.8mm).....18	A10-01-1 1/4 (12142C-1 1/4)....9	CF363 4.8mm.....7
51742-G(2.2mm)(91-051742-03)....18	A10-01-1 1/8 (12142C-1 1/8)....9	CF363V 4.8mm.....7
520-4.....10	A10-01-1 3/8 (12142C-1 3/8)....9	CF363VNF 4.8mm.....7
521ZL(521Z).....42	A10-01-1" (12142C-1").....9	CF36 8mm.....7
521ZR.....42	A10-01-3/4 (12142C-3/4).....9	CF36L 8mm.....7
541566-10mm.....31	A10-01-7/8 (12142C-7/8).....9	CF36LN 4.6mm.....7
541781-10mm.....31	A227-1/2 (S537-1/2).....11	CF36LW 10mm.....7

CF36N 4.6mm.....7	CL1/16NS.....2	CL3/32K (221-1/2H).....2
CF36W 10mm.....7	CL1/16S.....3	CL3/32S.....3
CF3CH 4.8mm.....7	CL1/2.....3	CL3/8.....3
CF3CSH 4.8mm.....7	CL1/2E (228L).....2	CL3/8E (226L).....2
CF3DW 4.8mm.....46	CL1/2ES.....2	CL3/8ES.....2
CF3DW 5.6mm.....46	CL1/2K (228H).....2	CL3/8K (226H).....2
CF3DW 6.4mm.....46	CL1/2S.....3	CL3/8S.....3
CF457-1 (5.0 - 10).....41	CL1/32.....3	CL-30-3.0mm.....3
CF457-2 (7.5 - 12).....41	CL1/32E (22L).....2	CL-40-4.0mm.....3
CF457-3 (7.5 - 14).....41	CL1/32ES.....2	CL5/16.....3
CF457-4 (10.5 - 16).....41	CL1/32K (22H).....2	CL5/16E (225L).....2
CF457-5 (12.5 - 19).....41	CL1/32N (220L).....2	CL5/16ES.....2
CF457-6 (14.5 - 22).....41	CL1/32NK (220H).....2	CL5/16K (225H).....2
CF58N 8mm.....7	CL1/32NN (220LN).....2	CL5/16S.....3
CF810-1/32.....6	CL1/32NS.....2	CL5/32.....3
CF810L-1/32.....6	CL1/32S.....3	CL5/32E (222-1/2).....2
CF811-1/16.....6	CL1/4.....3	CL5/32ES.....2
CF8115-3/32.....6	CL1/4E (224L).....2	CL5/32K (222-1/2H).....2
CF8115L-3/32.....6	CL1/4ES.....2	CL5/32S.....3
CF811L-1/16.....6	CL1/4K (224H).....2	CL-50-5.0mm.....3
CF812-1/8.....6	CL1/4S.....3	CL-60-6.0mm.....3
CF812L-1/8.....6	CL1/8.....3	CL-65-6.5mm.....3
CF813-3/16.....6	CL1/8E (222L).....2	CL-70-7.0mm.....3
CF813L-3/16.....6	CL1/8ES.....2	CL-80-8.0mm.....3
CF814-1/4.....6	CL1/8K (222H).....2	CL831-NF1.....34
CF814L-1/4.....6	CL1/8S.....3	CL831-NFB(ART.1612/1).....34
CF815-5/16.....6	CL-100-10mm.....3	CL-90-9.0mm.....3
CF815L-5/16.....6	CL-10-1.0mm.....3	CR1/16.....3
CF816-3/8.....6	CL10N-1.0mm.....3	CR1/16E (211R).....2
CF816L-3/8.....6	CL-110-11mm.....3	CR1/16ES.....2
CF818-1/2.....6	CL-130-13mm.....3	CR1/16K (211H).....2
CF818L-1/2.....6	CL-15-1.5mm.....3	CR1/16S.....3
CHNR-1/16 (KR-1-1/16).....10	CL-15N-1.5mm.....3	CR1/16N (211N).....2
CHNR-1/32 (KR-1-1/32).....10	CL-20-2.0mm.....3	CR1/16NK (211NH).....2
CHNL-1/16 (KL-1-1/16).....10	CL-25-2.5mm.....3	CR1/16NN (211NN).....2
CHNL-1/32 (KL-1-1/32).....10	CL3/16.....3	CR1/16NS.....2
CL1/16.....3	CL3/16E (223L).....2	CR1/2.....3
CL1/16E (221L).....2	CL3/16ES.....2	CR1/2E (218R).....2
CL1/16ES.....2	CL3/16K (223H).....2	CR1/2ES.....2
CL1/16K (221H).....2	CL3/16S.....3	CR1/2K (218H).....2
CL1/16N (221N).....2	CL3/32.....3	CR1/2S.....3
CL1/16NK (221NH).....2	CL3/32E (221-1/2).....2	CR1/32.....3
CL1/16NN (221NN).....2	CL3/32ES.....2	CR1/32E (21R).....2

CR1/32ES.....2	CR5/16.....3	DK36D (ART.6647).....36
CR1/32K (21H) .....2	CR5/16E (215R).....2	DK36L (ART.1686).....36
CR1/32N (210R).....2	CR5/16ES.....2	DK36LN (ART.1681).....36
CR1/32NK (210H).....2	CR5/16K(215H) .....2	DK36N (ART.1682).....36
CR1/32NN (210RN).....2	CR5/16S.....3	DK518.....36
CR1/32NS.....2	CR5/32.....3	DK518N.....36
CR1/32S.....3	CR5/32E (212-1/2).....2	DK-810 1/32.....38
CR1/4.....3	CR5/32ES.....2	DK-811 1/16.....38
CR1/4E (214R).....2	CR5/32K(212-1/2H).....2	DK-812 1/8.....38
CR1/4ES.....2	CR5/32S.....3	DK-813 3/16.....38
CR1/4K (214H).....2	CR-50-5.0mm.....3	DK-814 1/4.....38
CR1/4S.....3	CR-60-6.0mm.....3	DK-815 5/16.....38
CR1/8.....3	CR-65-6.5mm.....3	DK-820 1/32.....38
CR1/8E (212R).....2	CR-70-7.0mm.....3	DK-821 1/16.....38
CR1/8ES.....2	CR-80-8.0mm.....3	DK-822 1/8.....38
CR1/8K (212H).....2	CR-90-9.0mm.....3	DK-823 3/16.....38
CR1/8S.....3	D-1421-555-DOO.....17	DK-824 1/4.....38
CR-100-10mm.....3	D36H-8.0mm.....14	DK-825 5/16.....38
CR-10-1.0mm.....3	D36NH-4.8mm.....14	DKMT-1 (ART .1603).....36
CR-10N-1.0mm.....3	DK-10G (0~20mm)(DK10G-CRL).35	DKMT-1B.....36
CR-110-11mm.....3	DK127 (212-903)(ART.6650)....37	G10-457 (0~20mm)(G10-457-CRL)....40
CR-130-13mm.....3	DK127W (212-1643)(ART.1289)....37	G10-570 1/4(0~20mm)(G10-570-CRL).39
CR-15-1.5mm.....3	DK127WK(212-887)(ART.1285)....37	G10-570 1/8(0~20mm)(G10-570-CRL).39
CR-15N-1.5mm.....3	DK211 (ART.1620/4-1/16).....37	G10-570 3/16(0~20mm)(G10-570-CRL).39
CR-20-2.0mm.....3	DK212 (ART.1620/6-1/8).....37	G10-570 3/8 (0~20mm)(G10-570-CRL).39
CR-25-2.5mm.....3	DK213 (ART.1620/8-3/16).....37	G10-570 <sub>5/16</sub> (0~20mm)(G10-570-CRL).39
CR3/16.....3	DK214 (ART.1620/10-1/4).....37	G10-652 (0~20mm)(G10-652-CRL).....30
CR3/16E (213R).....2	DK215 (ART.1620/12-5/16).....37	G10-CRL (0~20mm)(G10-CRL).....1
CR3/16ES.....2	DK216 (ART.1620/14-3/8).....37	G10-NF (0~20mm)(G10-NF-CRL).....26
CR3/16K (213H).....2	DK218 (ART.1620/16-1/2).....37	H10-1.0mm.....21
CR3/16S.....3	DK21R (ART.1620/2-1/32).....37	H15-1.5mm (ART.1926/1).....21
CR3/32.....3	DK221 (ART.1620/3-1/16).....37	H15-69HL1/4-6.4mm.....21
CR3/32E (21 1-1/2).....2	DK222 (ART.1620/5-1/8).....37	H15-69HL1/8-3.2mm.....21
CR3/32ES.....2	DK223 (ART.1620/7-3/16).....37	H15-69HL3/16-4.8mm.....21
CR3/32K (211-1/2H).....2	DK224 (ART.1620/9-1/4).....37	H15SH 2.0mm(2858).....21
CR3/32S.....3	DK225 (ART.1620/11-5/16).....37	H15SH 2.5mm(2858).....21
CR3/8.....3	DK226 (ART.1620/13-3/8).....37	H15SH 3.0mm(2858).....21
CR3/8E (216R).....2	DK228 (ART.1620/15-1/2).....37	H15SH 4.0mm(2858).....21
CR3/8ES.....2	DK22L (ART.1620/1-1/32).....37	H15ZZ-3.0mm(ART.1929).....21
CR3/8K (216H).....2	DK351 (212-1193)(ART.1309)....37	H15Z.....21
CR3/8S.....3	DK36 (ART.1687).....36	H15ZZ-6.0mm(ART.1929).....21
CR-30-3.0mm.....3	DK363 (ART.1623).....36	H20-2.0mm.....21
CR-40-4.0mm.....3	DK363W (ART.1685).....36	H25-2.5mm (ART.1926/2).....21



H30-3.0mm (AR T.1926/3).....21	LF-60-6.0mm.....5	NH8320 (ART.1625/1-1/32)(NARROW)....33
H40-4.0mm (AR T.1926/4).....21	LF-65-6.5mm.....5	NH8321 (ART.1625/4-1/16)....33
H50-5.0mm (AR T.1926/5).....21	LF-70-7.0mm.....5	NH8330D-DOUBLE (ART.1625/3-1/32)....33
H60-6.0mm (AR T.1926/6).....21	LF-80-8.0mm.....5	NH8331D-DOUBLE (ART.1625/3-1/16)....34
K1 NEEDLE PLATE.....20	LF-90-9.0mm.....5	NH8810(ART.1626/2-1/32).....29
K2 FEED DOG.....20	MAS-07300-AA0 (#SS1 #PB-3 #NBBF)48	NH8811 (ART.1626/4-1/16)....29
K3 FOOT.....20	MT-1.....23	NH8811N-1/16(NARROW).....29
LF1/16.....5	MT1-NF (ART.1602).....29	NH8812 (ART.1626/5-1/8).....29
LF1/16K (PF221L).....5	MT1-NFB.....29	NH8813 (ART.1626/6-3/16)....29
LF1/16N.....5	MT-2.....23	NH8814 (ART.1626/7-1/4).....29
LF1/16NK (PF221N).....5	MT541566 12mm.....32	NH8815 (ART.1626/8-5/16)....29
LF1/2.....5	MT541566 5mm.....32	NH8816 (ART.1626/9-3/8).....29
LF1/2K (PF228L).....5	MT541566B 12mm.....32	NH8820 (ART.1626/1-1/32)....29
LF1/32.....5	MT541566B 5mm.....32	NH8821 (ART.1626/3-1/16)....29
LF1/32K (PF22L).....5	NH-10G-0~20mm (NH10G-CRL).....29	NH8821N-1/16(NARROW).....29
LF1/32N.....5	NH127 13mm.....30	NHD248 (ART.1679/1 4.8mm-2.0mm).....35
LF1/32NK (PF220L).....5	NH127W 14mm.....30	NHD264 (ART.1679/2 6.4mm-2.0mm).....35
LF1/4.....5	NH248 (ART.1623/1 4.8mm)(#961799-3-00)35	NHG248-2R(ART.1652/1 4.8mm-2.0mm)35
LF1/4K (PF224L).....5	NH248H (ART.6645/1 4.8mm).....35	NHG248H(ATR.6646/1 4.8mm-2.0mm)....35
LF1/8.....5	NH248N (ART.1698/1 4.8mm).....35	NHG264-2R(ART.1652/2 6.4mm-2.0mm)35
LF1/8K (PF222L).....5	NH260(ART.1623/2 6mm)(#961773-3-00)35	NHG264H (ART.6646/2 6.4mm-2.0mm)....35
LF-100-10mm.....5	NH264 (ART.1623/3 6.4mm)(#961773-3-10)35	NHR248 (ART.1627/1 4.8mm-2.0mm)....35
LF-10-1.0mm.....5	NH264H (ART.6645/2 6.4mm).....35	NHR264 (ART.1627/2 6.4mm-2.0mm)....35
LF-10N-1.0mm.....5	NH264N(ART.1698/2 6.4mm).....35	NL-31G.....1
LF-120-12mm.....5	NH35(ART.1551) (#961789-3-00) 11mm.....30	NL31G-NF.....26
LF-130-13mm.....5	NH351 11mm.....30	NR-31G.....1
LF-15-1.5mm.....5	NH351W(ART.1552)(#961761-3-00)12.7mm...30	NR-31G-NF.....26
LF-15N-1.5mm.....5	NH36-1 7.0mm.....34	NT-18.....24
LF-20-2.0mm.....5	NH363 (ART.1646) 5.4mm.....30	NT-18B.....24
LF-25-2.5mm.....5	NH363-1 (ART.1643) 5.4mm.....34	P01 (36464N).....24
LF3/16.....5	NH36L-1 7.0mm.....34	P01W (3646W).....24
LF3/16K (PF223L).....5	NH36LN (ART.1647) 5.4mm.....29	P10 (36465-1/32).....24
LF3/32.....5	NH36LN-1(ART.1641) 5.4mm.....34	P11 (36465-1/16).....24
LF3/32K (PF221 1/2).....5	NH36N (ART.1648) 5.4mm.....30	P115 (36465-3/32).....12
LF3/8.....5	NH36N-1 (ART.1642) 5.4mm.....34	P12 (36465-1/8).....12
LF3/8K (PF226L).....5	NH8310 (ART.1625/2-1/32)(NARROW)....33	P127 (127233).....17
LF-30-3.0mm.....5	NH8311 (ART.1625/5-1/16).....33	P127-NF (ART.6643).....28
LF-40-4.0mm.....5	NH8311N-1/16 (NARROW).....33	P127WK-NF.....28
LF5/16.....5	NH8312 (ART.1625/6-1/8).....33	P127W-NF (ART.6644).....28
LF5/16K (PF225L).....5	NH8313 (ART.1625/7-3/16).....33	P13 (36465-3/16).....12
LF5/32.....5	NH8314 (ART.1625/8-1/4).....33	P14 (36465-1/4).....12
LF5/32K (PF222 1/2).....5	NH8315 (ART.1625/9-5/6).....33	.....
LF-50-5.0mm.....5	NH8316 (ART.1625/10-3/8).....33	.....

P144H (12144H).....15	P3625-3/4 (S542-1").....9	P69L1/8 (36069L1/8).....8
P144HL (12144HLD).....15	P363 (40322SH).....13	P69L3/16 (36069L 3/16).....8
P144HLB (12144HLB).....15	P363-NF (S363NF)(ART.1680)..27	P69L3/8 (36069L 3/8).....8
P15 (36465-5/16).....12	P363V (165010H).....13	P69LH1/16 (L36069H1/16).....8
P16 (36465-3/8).....12	P363VNF.....28	P69LH1/4 (L36069H1/4).....8
P18 (36465-1/2).....12	P363W-NF(ART.1688).....27	P69LH1/8 (L36069H1/8).....8
P193 (19336).....16	P36D-NF (ART.6648).....29	P69LH3/16 (L36069H3/16).....8
P27 (S5050N)(149027)(149085).....28	P36L (31358HW).....14	P69LH-NF 1/4.....25
P3 (165010).....13	P36LN (31358HN).....14	P69LH-NF 1/8.....25
P301 (31358W).....13	P36L-NF (S0080)(ART.1689).....27	P69LH-NF 3/16.....25
P301C1/4 (31358L 1/4).....8	P36LN-NF (S0050N)(ART.1683)..27	P69LH-NF 5/16.....25
P301C1/8 (31358L 1/8).....8	P36LW (31358HXW).....14	P69R1/16 (36069R 1/16).....8
P301C3/16 (31358L 3/16).....8	P36N (12435HN).....13	P69R1/2 (36069R 1/2).....8
P301N (31358N).....13	P36-NF (S8000N)(ART.1690)..27	P69R1/4 (36069R 1/4).....8
P31 (12435W).....13	P36N-NF (S5000N)(ART.1684)..27	P69R1/8 (36069R 1/8).....8
P311 (12143).....10	P36W (12435HXW).....14	P69R3/16 (36069R 3/16).....8
P311N (12435N).....13	P375 (241375).....43	P69R3/8 (36069R 3/8).....8
P31C1/4 (12435R 1/4).....8	P375BL.....43	P69RH1/16(R36069H1/16).....8
P31C1/8 (12435R 1/8).....8	P37M-MED. GROVE.....9	P69RH1/4 (R36069H1/4).....8
P31C3/16 (12435R 3/16).....8	P37-SMALL GROVE.....9	P69RH1/8 (R36069H1/8).....8
P33 (12142).....10	P37W-LARGE GROVE.....9	P69RH3/16 (R36069H3/16).....8
P34.....10	P3811-1/4 (S538-1/4).....9	P69RH-NF 1/4.....25
P344.....10	P3819-1/2 (S539-1/2).....9	P69RH-NF 1/8.....25
P35 (24983).....15	P3822-5/8 (5/8).....9	P69RH-NF 3/16.....25
P351 (52427).....16	P3825-3/4 (S540-3/4").....9	P69RH-NF 5/16.....25
P351K.....16	P39-PLAIN.....9	P723 (S521)(3/16"~2")..16
P351KS.....3	P3C (40322).....13	P723-NF 5mm~50mm.....27
P351-NF 11mm(S351NF).....28	P3CS (40322CS).....13	P801 (1/32"~3/4").....16
P351N-NF 9.0mm.....27	P50 (120828).....11	P803 (3/16"~7/8").....16
P352.....16	P50H (120828H).....11	P81 (S523)(1/32"~3/4").....16
P35G.....24	P50M (120828M).....11	P810 (12463H 1/32).....7
P35G-NF.....27	P50N (120828N).....11	P810L (L12436H 1/32).....7
P35K (24983K).....15	P58N (142058N).....15	P810-NF 1/32 1.0mm.....25
P36 (12435HW).....14	P58W (142058W).....15	P811 (12463H 1/16).....7
P360 (121947H).....14	P5R (P5).....12	P8115 (12463H 3/32).....7
P360-NF (S2060N).....27	P5W.....12	P8115L (L12463H 3/32).....7
P361 (121950H).....14	P69D1/16 (36069DG 1/16).....9	P811L (L12463H 1/16).....7
P3610 15/64(5/8).....9	P69D1/4 (36069DG 1/4).....9	P811-NF 1/16 1.6mm.....25
P3613-9/32 (S542-1/2).....9	P69D1/8 (36069DG 1/8).....9	P812 (12463H 1/8).....7
P3619-1/2 (S542-3/4).....9	P69D3/16 (36069DG 3/16).....9	P812L (L12463H 1/8).....7
P361-NF (S6020N).....27	P69L1/16 (36069L 1/16).....8	P812-NF 1/8 3.2mm.....25
P3620 13/32 (13/16).....9	P69L1/2 (36069L 1/2).....8	P813 (12463H 3/16).....7
P3622-5/8 (S542-7/8).....9	P69L1/4 (36069L 1/4).....8	P813L (L12463H 3/16).....7

P813-NF 3/16 4.8mm.....25	PFG264 (ART.1651/2-mm6.4-1.0mm), 33	R-361-8mm (HM1-4).....20
P814 (12463H 1/4).....7	PFG248-1L (ART.1557/1 4.8mm-1.0mm), 34	R-36-8mm (HM2-1).....20
P814L (L12463H 1/4).....7	PFG248-1R(ART.1695/1 4.8mm-1.0mm), 34	R-36L-8mm (HM2-2).....20
P814-NF 1/4 6.4mm.....25	PFG248-2L (ART.1557/2 4.8mm-2.0mm), 34	R-36LN-5mm (HM2-4).....20
P815 (12463H 5/16).....7	PFG248-2R(ART.1695/2 4.8mm-2.0mm), 34	R-36LW-10mm .....20
P815L (L12463H 5/16).....7	PFG264 (ART.1651/2-mm6.4-2.0mm), 33	R-36N-5mm (HM2-3).....20
P815-NF 5/16 8.0mm.....25	PFG264-1L (ART.1558/1 6.4mm-1.0mm), 34	R-36W-10mm.....20
P816 (12463H 3/8).....7	PFG264-1R (ART.1696/1 6.4mm-1.0mm), 34	R-3DWG 4.8mm (輪子三本用)...46
P816L (L12463H 3/8).....7	PFG264-2L (ART.1558/2 6.4mm-2.0mm), 34	R-3DWG 5.6mm (輪子三本用)...46
P816-NF 3/8 9.6mm.....25	PFG264-2R (ART.1696/2 6.4mm-2.0mm), 34	R-3DWG 6.4mm (輪子三本用)...46
P818 (12463H 1/2).....7	PFK-161-LIGHTEST(CFK-161).....6	R-3DW-G10 4.8mm (輪子三本用).....46
P818L (L12463H 1/2).....7	PFK-261-LIGHTEST W/TAIL(CFK-261).....6	R-3DW-G10 5.6mm (輪子三本用).....46
P820-NF 1/32 1.0mm.....25	PFR248 (ART.1628/1-mm4.8), .....33	R-3DW-G10 6.4mm (輪子三本用).....46
P821-NF 1/16 1.6mm.....25	PFR264 (ART.1628/2-mm6.4), .....33	R4-1 (HM6-1-2).....47
P822-NF 1/8 3.2mm.....25	R-1 (HM1-1)LIGHT.....33	R4-2 (HM6-1-4).....47
P823-NF 3/16 4.8mm.....25	R-1/16L.....20	R-457-1(17.5-7.5)(HM4-5) (輪子人字車)...41
P824-NF 1/4 6.4mm.....25	R-1/16LN.....20	R-457-2(20.5-10.5)(HM4-7)(輪子人字車)...41
P825-NF 5/16 8.0mm.....25	R-1/16R.....20	R-457-3(22.5-12.5)(輪子人字車)...41
P826-NF 3/8 9.6mm.....25	R-1/16RN (HM1/16).....20	R-457-4(24.5-14.5)(HM4-3)(輪子人字車)...41
P882 (229882).....43	R-1/32L.....20	R-5/16L.....20
P946 (121946).....25	R-1/32LN.....20	R-5/16R (HM5/16).....20
P983 (25983).....11	R-1/32R.....20	R-5/32R (HM5/32).....20
PF00 (CF00).....6	R-1/32RN (HM1/32).....20	R-5/64L.....20
PF10G-0~20mm(PFG10-CRL).....32	R-1/4L.....20	R-5/64R (HM5/64).....20
PF-131-HEAVY(CF-131-HEAVY)....6	R-1/4R (HM1/4).....20	R5-1X3mm (HM6-2-1X3mm).....47
PF-141-MEDIUM (CF-141-MEDIUM), 6	R-1/8L.....20	R5-1X5mm (HM6-2-1X5mm).....47
PF-151-LIGHT (CF-151-LIGHT)....6	R-1/8R (HM1/8).....20	R5-2X3mm (HM6-2-2X3mm).....47
PF-231-HEAVY (CF-231-HEAVY)....6	R-2 (HM1-2)MEDIUM.....19	R5-2X5mm (HM6-2-2X5mm).....47
PF-241-MEDIUM (CF-241-MEDIUM), 6	R-232-1/8" (輪子雙針用) HM7-1 1/8.....40	R-652-12mm(HM4-1).....31
PF248 (30715-3-00mm4.8).....33	R-248-3/16" (輪子雙針用) HM7-1 3/16.....40	R-652-6mm.....31
PF248-1 (ART.1694/1 4.8mm).....34	R-264-1/4" (輪子雙針用) HM7-1 1/4.....40	R-810 1/32.....19
PF-251-LIGHT (CF-251-LIGHT)..6	R-280-5/16" (輪子雙針用) HM7-1 5/16.....40	R-810L 1/32.....19
PF260 (961044-3-00mm6.0).....33	R-295-3/8" (輪子雙針用) HM7-1 3/8.....40	R-811 1/16 (HM3-1).....19
PF264 (961044-3-10mm6.4).....33	R2E.....19	R-811L 1/16.....19
PF264-1 (ART.1694/2 6.4mm) .....34	R-3 (HM1-3)HEAVY.....19	R-812 1/8 (HM3-2).....19
PF518L (CF518L).....7	R-3/16L.....20	R-812L 1/8.....19
PF518N (CF518N).....7	R-3/16R (HM3/16).....20	R-813 3/16.....19
PF-A1L.....42	R-3/32L.....20	R-813L 3/16.....19
PF-A1R.....42	R-3/32R (HM3/32).....20	R-814 1/4.....19
PFD248 (ART.1639/1-mm4.8).....33	R3-1 (HM6-1-1).....47	R-814L 1/4.....19
PFD264 (ART.1639/2-mm6.4).....33	R3-2 (HM6-1-3).....47	R-815 5/16.....19
PFG248 (ART.1651/1-mm4.8-1.0mm)....33	R-351-NF-12mm(HM1-5).....27	R-815L 5/16.....19
PFG248 (ART.1651/1-mm4.8-2.0mm)....33	R-360-8mm.....20	RF1/16.....5

RF1/16K (PF21 1R).....5	S10C-1/8 (P318C1/8).....12	S534 (A225).....11
RF1/16N.....5	S10C-3/16 (P3316C3/16).....12	S536.....20
RF1/16NK (PF211N).....5	S10C-3/4 (P334C3/4).....12	S541" (1-5/16").....9
RF1/2.....5	S10C-3/8 (P338C3/8).....12	S543 (CHN).....10
RF1/2K (PF218R).....5	S10C-5/16 (P3516C5/16).....12	S544 (CHW).....10
RF1/32.....5	S10C-5/8 (P358C5/8).....12	S545 (P38).....11
RF1/32K (PF21R).....5	S10L-1" (P325L1").....12	S570-A25 1/8 (5~50mm).....39
RF1/32N.....5	S10L-1/2 (P312L1/2).....12	S570-A25 3/16(5~50mm).....39
RF1/32NK (PF210).....5	S10L-1/4 (P314L1/4).....12	S570-A25 1/4 (5~50mm).....39
RF1/4.....5	S10L-1/8 (P318L1/8).....12	S570-A25 5/16 (5~50mm).....39
RF1/4K (PF214R).....5	S10L-3/16 (P3316L3/16).....12	S570GK-1/4 (可調式雙針靠檔).....40
RF1/8.....5	S10L-3/4 (P334L3/4).....12	S570GK-1/8 (可調式雙針靠檔).....40
RF1/8K (PF212R).....5	S10L-3/8 (P338L3/8).....12	S570GK-3/16 (可調式雙針靠檔).....40
RF-100-10mm.....5	S10L-5/16 (P3516L5/16).....12	S570GK-3/8 (可調式雙針靠檔).....40
RF-10-1.0mm.....5	S10L-5/8 (P358L5/8).....12	S570GK-5/16 (可調式雙針靠檔).....40
RF-10N-1.0mm.....5	S10R-1" (P325R1").....12	S570S-1/2-1/16 (針距-邊距).....38
RF-120-12mm.....5	S10R-1/2 (P312R1/2).....12	S570S-1/2-1/32 針距 邊距 (...)...38
RF-130-13mm.....5	S10R-1/4 (P314R1/4).....12	S570S-1/4-1/16 針距 邊距 (...)...38
RF-15-1.5mm.....5	S10R-1/8 (P318R1/8).....12	S570S-1/4-1/32 針距 邊距 (...)...38
RF-15N-1.5mm.....5	S10R-3/16 (P3316R3/16).....12	S570S-1/8-1/16 針距 邊距 (...)...38
RF-20-2.0mm.....5	S10R-3/4 (P334R3/4).....12	S570S-1/8-1/32 針距 邊距 (...)...38
RF-25-2.5mm.....5	S10R-3/8 (P338R3/8).....12	S570S-3/16-1/16 針距 邊距 (...)...38
RF3/16.....5	S10R-5/16 (P3516R5/16).....12	S570S-3/16-1/32 針距 邊距 (...)...38
RF3/16K (PF213R).....5	S10R-5/8 (P358R5/8).....12	S570S-3/8-1/16 針距 邊距 (...)...38
RF3/32.....5	S457AT (503896)5~20mm.....41	S570S-3/8-1/32 針距 邊距 (...)...38
RF3/32K (PF211 1/2).....5	S457AT-G (503896-G)5~20mm.....41	S570S-5/16-1/16 針距 邊距 (...)...38
RF3/8.....5	S510.....14	S570S-5/16-1/32 針距 邊距 (...)...38
RF3/8K (PF216R).....5	S515 (CF2-S).....18	S570SD-1/4-1/16 (針距-邊距).....39
RF-30-3.0mm.....5	S516 (CFR-S).....18	S570SD-1/4-1/32 (針距-邊距).....39
RF-40-4.0mm.....5	S518-2.0mm.....15	S570SD-1/8-1/16 (針距-邊距).....39
RF5/16.....5	S518A.....15	S570SD-1/8-1/32 (針距-邊距).....39
RF5/16K (PF215R).....5	S518H-2.5mm.....15	S570SD-3/16-1/16(針距-邊距).....39
RF5/32.....5	S518L.....15	S570SD-3/16-1/32(針距-邊距).....39
RF5/32K (PF212 1/2).....5	S518N.....15	S570SL-1/2-1/16 針距 邊距 (...)...38
RF-50-5.0mm.....5	S518NE.....15	S570SL-1/2-1/32 針距 邊距 (...)...38
RF-60-6.0mm.....5	S518-NF (ART.1525/1).....29	S570SL-1/4-1/16 針距 邊距 (...)...38
RF-65-6.5mm.....5	S518N-G.....15	S570SL-1/4-1/32 針距 邊距 (...)...38
RF-70-7.0mm.....5	S518N-NF (ART.1526/1).....28	S570SL-1/8-1/16 針距 邊距 (...)...38
RF-80-8.0mm.....5	S518S.....15	S570SL-1/8-1/32 針距 邊距 (...)...38
RF-90-9.0mm.....5	S524 (7/32"~1").....16	S570SL-3/16-1/16 針距 邊距 (...)...38
S10C-1" (P325C1").....12	S530S.....13	S570SL-3/16-1/32 針距 邊距 (...)...38
S10C-1/2 (P312C1/2).....12	S531L.....13	S570SL-3/8-1/16 針距 邊距 (...)...38
S10C-1/4 (P314C1/4).....12	S532 (P312SB).....11	S570SL-3/8-1/32 針距 邊距 (...)...38

S570SL-5/16-1/16(針距-邊距).....38	SP-44.....17	TCL1/4B (MT224B).....22
S570SL-5/16-1/32(針距-邊距).....38	SP-60 (S402).....17	TCL1/8 (MT222).....22
S70F-1/16.....9	SP-61 (S801).....17	TCL1/8B (MT222B).....22
S70F-1/2.....9	SP-62 (S802).....17	TCL3/16 (MT223).....22
S70F-1/4.....9	SP-63 (S803).....17	TCL3/16B (MT223B).....22
S70F-1/8.....9	SP-64 (S804).....17	TCL3/32 (MT221 1/2).....22
S70F-3/16.....9	SP-65 (S400).....17	TCL3/32B (MT221 1/2B).....22
S70F-3/8.....9	SPK-3.....19	TCL3/8 (MT226).....22
S70F-5/16.....9	SR-1.....10	TCL3/8B (MT226B).....22
S950 (P950).....12	SR-DB-H (尼龍帶) (TRF-1-R).....18	TCL5/16 (MT225).....22
S952 (P952).....12	SR-DB-L.....18	TCL5/16B (MT225B).....22
SDRF.....19	SR-DB-R.....18	TCR1/16 (MT211).....22
SP18-1/16 1.6mm.....4	SR-DB-W (TRF-1).....18	TCR1/16B (MT211B).....22
SP18-1/32 1.0mm.....4	T35 1mm.....23	TCR1/16N (MT211N).....22
SP18-1/4 6.4mm.....4	T350 11mm.....23	TCR1/16NB (MT211NB).....22
SP18-1/8 3.2mm.....4	T350B 11mm.....23	TCR1/2 (MT218).....22
SP18-3/16 4.8mm.....4	T35B 11mm.....23	TCR1/2B (MT218B).....22
SP18-3/32 2.4mm.....4	T35C 11mm.....23	TCR1/32 (MT21R).....22
SP18-3/8 9.6mm.....4	T35CB 11mm.....23	TCR1/32B (MT21RB).....22
SP18-5/16 8.0mm.....4	T35CW 12.7mm.....23	TCR1/32N (MT210).....22
SP18L-1/16 1.6mm.....4	T35CWB 12.7mm.....23	TCR1/32NB (MT210B).....22
SP18L-1/32 1.0mm.....4	T35W 12.7mm.....23	TCR1/4 (MT214).....22
SP18L-1/4 6.4mm.....4	T35WB 12.7mm.....23	TCR1/4B (MT214B).....22
SP18L-1/8 3.2mm.....4	T36 10.5mm.....23	TCR1/8 (MT212).....22
SP18L-3/16 4.8mm.....4	T363 6mm.....23	TCR1/8B (MT212B).....22
SP18L-3/32 2.4mm.....4	T363B 6mm.....23	TCR3/16 (MT213).....22
SP18L-3/8 9.6mm.....4	T36B 10.5mm.....23	TCR3/16B (MT213B).....22
SP18L-5/16 8.0mm.....4	T36L 10.5mm.....23	TCR3/32 (MT211 1/2).....22
SP18L-NF 1/16 1.6mm.....25	T36LB 10.5mm.....23	TCR3/32B (MT211 1/2B).....22
SP18L-NF 1/32 1.0mm.....25	T36LN 6mm.....23	TCR3/8 (MT216).....22
SP18L-NF 1/4 6.4mm.....25	T36LNB 6mm.....23	TCR3/8B (MT216B).....22
SP18L-NF 1/8 3.2mm.....25	T36N 6mm.....23	TCR5/16 (MT215).....22
SP18L-NF 3/16 4.8mm.....25	T36NB 6mm.....23	TCR5/16B (MT215B).....22
SP18L-NF 3/32 2.4mm.....25	TCL1/16 (MT221).....22	US12435HN.....21
SP18L-NF 3/8 9.6mm.....25	TCL1/16B (MT221B).....22	US12435HW.....21
SP18L-NF 5/16 8.0mm.....25	TCL1/16N (MT221N).....22	US31-1/32.....21
SP18-NF 1/16 1.6mm.....25	TCL1/16NB (MT221NB).....22	US311-1/16.....21
SP18-NF 3/32 2.4mm.....25	TCL1/2 (MT228).....22	US312-1/8.....21
SP18-NF 1/32 1.0mm.....25	TCL1/2B (MT228B).....22	US313-3/16.....21
SP18-NF 1/4 6.4mm.....25	TCL1/32 (MT22).....22	US31358HN.....21
SP18-NF 1/8 3.2mm.....25	TCL1/32B (MT22B).....22	US31358HW.....21
SP18-NF 3/16 4.8mm.....25	TCL1/32N (MT220).....22	US314-1/4.....21
SP18-NF 3/8 9.6mm.....25	TCL 1/32NB (MT220B).....22	US40322SH.....21
SP18-NF 5/16 8.0mm.....25	TCL1/4 (MT224).....22	YS-37 (NP-37).....22



**YIH**  **SHIN**

SINCE 1975

**INDUSTRIAL SEWING MACHINE  
PARTS & ACCESSORIES**

**MANUFACTURING & WHOLESALING**

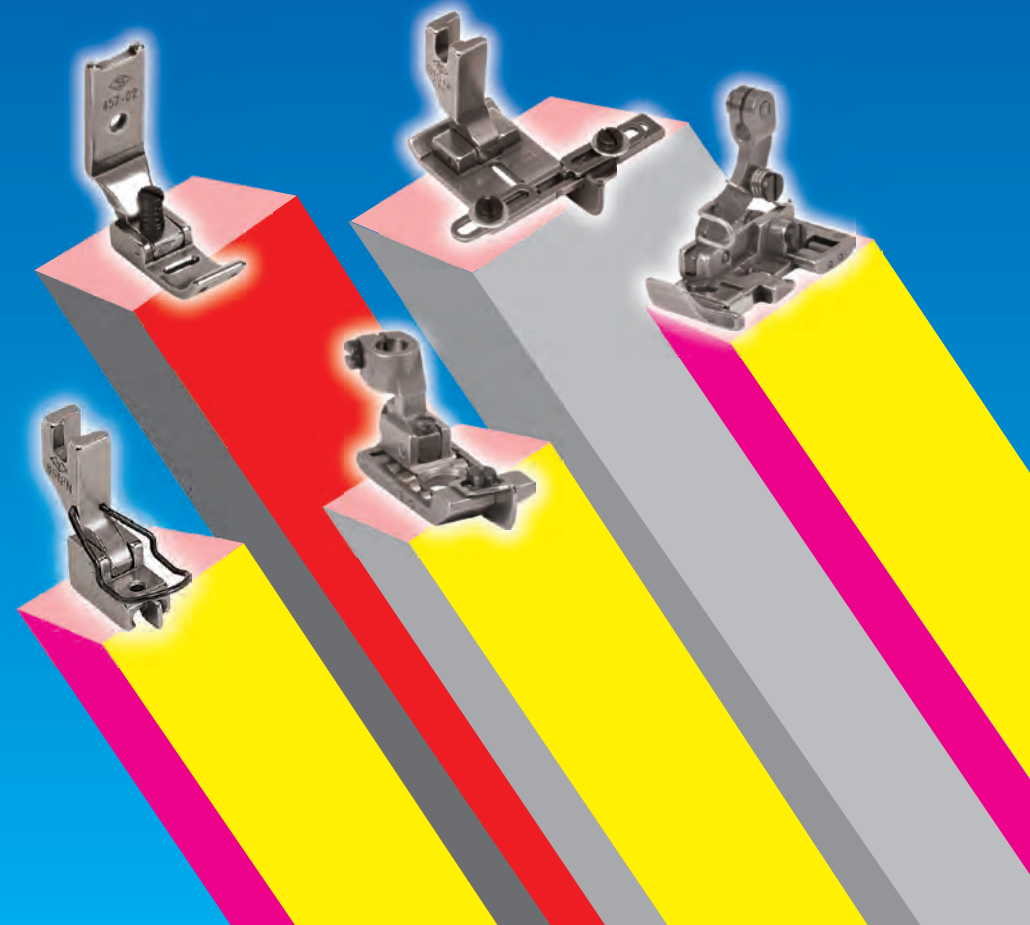

**YIH**  **SHIN**

SINCE 1975

**邑新針車企業有限公司**  
**YIH SHIN SEWING MACHINE CO., LTD**  
TAIPEI • TAIWAN

# YIH SHIN



SINCE 1975



"YIH SHIN" was established since 1975, we have very good experience, knowledge, and special technical to produce series industrial sewing machine presser foot. As well as, we have plenty of stock items in our warehouse, our goals are to help each of you remain competitive ability in a global environment.

In addition, we always design new product to solve the technical difficulty to work, we accept special order to any customers, as well as, we often help the factory of the foreign countries and my own country to make most of special design foot.

For example, BROTHER, PEGASUS, SINGER, JUKI, TOYOTA, PFAFF, BRUDAN etc.

YIH SHIN's products are high level and good quality, popular to sell in all the world, our major market in Europe, Japan, American etc.

Your advise and ordering are our pleasure, we will give you best service at anytime,

Sincerely!

YIH SHIN INDUSTRIAL SEWING MACHINE CO., LTD.

PRESIDENT

邑新公司創立於1975年，擁有豐富的經驗、專業知識及特殊的設備，生產一系列的工業用縫紉機押布腳。

同時具有充足的庫存可以隨時供應客戶所需，如此才能配合客戶在全球競爭力的提升，這是邑新公司的經營理念。

除此之外，邑新公司經常為客戶設計一些特殊的押腳，以解決技術上操作的困難，並且接受客戶的訂製，同時協助國內外工廠生產許多特殊設計的押腳，例如：兄弟、飛馬、勝家、幸福、豐田、百福、百慕達...等等。

邑新高品質的產品行銷於全世界，主要的市場是在高科技的國家，如歐洲、日本、美國...等等。

你的指教與訂貨是我們的榮幸，無論何時我們將給你最好的服務！

邑新針車企業有限公司 董事長



# YIH SHIN



SINCE 1975

YIH SHIN COMPANY was confirmation and acceptable by most of customers in all the word since 1975.

創立於1975年，邑新公司的產品在全世界已廣受肯定與好評。

總經理：劉運達

## PRECISION DURABLE CREATION

### 精密

### 耐用

### 創新

SO THAT , IN ORDER TO PROTECTION THE USERS SAFETY TO WORK , WE CAN OFFER THE SAFETY FINGER GUARD INSERT THE AVAILABLE DIFFERENT KIND OF PRESSER FOOT AS YOU REQUEST.

為了保護使用者在操作上的安全,我們可以根據客人的所需,提供安全護手,裝置在不同型態的押腳上。

PLEASE REFER THE DRAWING AS FOLLOWING

請參考下列代表型式的護手押腳。



<http://www.yihshin.com>

E-mail: [y5127@livemail.tw](mailto:y5127@livemail.tw)

※Homepage just for reference, please contact to our agent for more details.

本公司網站僅供查詢，欲購本公司產品請洽各大經銷商