

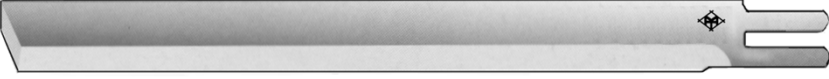

STRAIGHT KNIVES FOR COMET

	5C	9C	5C-HSS	9C-HSS
	6C	10C	6C-HSS	10C-HSS
	7C	11C	7C-HSS	11C-HSS
	8C	12C	8C-HSS	12C-HSS
	ALLOY STEEL		HIGH SPEED STEEL	

STRAIGHT KNIVES FOR EASTMAN

	4E		4E-HSS	
	5E	9E	5E-HSS	9E-HSS
	6E	10E	6E-HSS	10E-HSS
	7E	11-1/2"E	7E-HSS	11-1/2"E-HSS
	8E	13E	8E-HSS	13E-HSS
ALLOY STEEL		HIGH SPEED STEEL		

STRAIGHT KNIVES FOR HITAKA

	4H		4H-HSS	
	5H	8H	5H-HSS	8H-HSS
	6H	9H	6H-HSS	9H-HSS
	7H	10H	7H-HSS	10H-HSS
	ALLOY STEEL		HIGH SPEED STEEL	

STRAIGHT KNIVES FOR KM

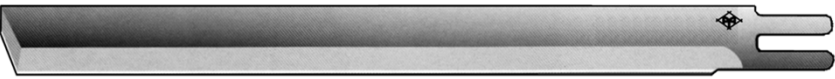
	4KM(N)		4KM(N)-HSS	
	5KM(N)	8KM	5KM(N)-HSS	8KM-HSS
	6KM(N)	9KM	6KM(N)-HSS	9KM-HSS
	6KM	10KM	6KM-HSS	10KM-HSS
	7KM	13KM	7KM-HSS	13KM-HSS
ALLOY STEEL		HIGH SPEED STEEL		

STRAIGHT KNIVES FOR KURIS

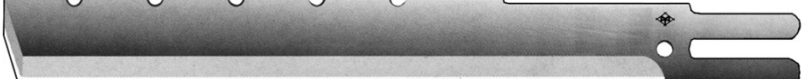
			6K-HSS	
			7K-HSS	
			8K-HSS	
			10K-HSS	
			HIGH SPEED STEEL	

STRAIGHT KNIVES FOR LIGHTNING

	6L		6L-HSS	
	8L		8L-HSS	
	10L		10L-HSS	
	12L		12L-HSS	
	14L		14L-HSS	
ALLOY STEEL		HIGH SPEED STEEL		

STRAIGHT KNIVES FOR MAMIN

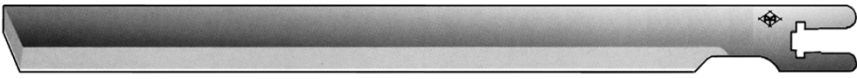
	4M		4M-HSS	
	5M	9M	5M-HSS	9M-HSS
	6M	10M	6M-HSS	10M-HSS
	7M	11M	7M-HSS	11M-HSS
	8M	14M	8M-HSS	14M-HSS
ALLOY STEEL		HIGH SPEED STEEL		

STRAIGHT KNIVES FOR WOLF

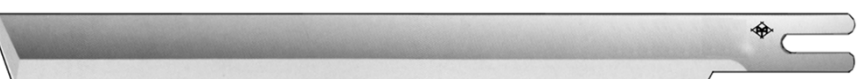
	4W		4W-HSS	8W-HSS
	5W	8W	5W-HSS	9W-HSS
	6W	9W	6W-HSS	10W-HSS
	7W	10W	7W-HSS	14W-HSS
	ALLOY STEEL		HIGH SPEED STEEL	

WAVE KNIVES FOR COMET

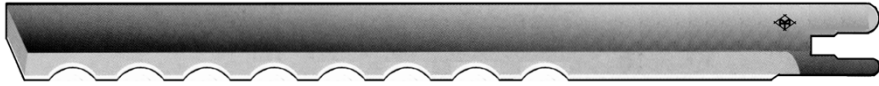

6CW
7CW
8CW
9CW
10CW
ALLOY STEEL

WAVE KNIVES FOR EASTMAN



5EW	5EW-HSS
6EW	6EW-HSS
7EW	7EW-HSS
8EW	8EW-HSS
9EW	9EW-HSS
10EW	10EW-HSS
ALLOY STEEL	HIGH SPEED STEEL

WAVE KNIVES FOR HITAKA



5HW	5HW-HSS
6HW	6HW-HSS
7HW	7HW-HSS
8HW	8HW-HSS
9HW	9HW-HSS
10HW	10HW-HSS
ALLOY STEEL	HIGH SPEED STEEL

WAVE KNIVES FOR KM



5KMW	5KMW-HSS
6KMW	6KMW-HSS
7KMW	7KMW-HSS
8KMW	8KMW-HSS
9KMW	9KMW-HSS
10KMW	10KMW-HSS
ALLOY STEEL	HIGH SPEED STEEL

WAVE KNIVES FOR MAIMIN







6MW	6MW-HSS
7MW	7MW-HSS
8MW	8MW-HSS
9MW	9MW-HSS
10MW	10MW-HSS
ALLOY STEEL	HIGH SPEED STEEL

WAVE KNIVES FOR WOLF



6WW	6WW-HSS
7WW	7WW-HSS
8WW	8WW-HSS
9WW	9WW-HSS
10WW	10WW-HSS
ALLOY STEEL	HIGH SPEED STEEL

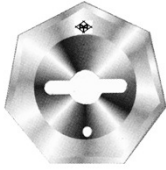



ROUND KNIVES FOR BEAVER AND HOOGS

<p>FOR BEAVER</p>  <p>R5 1/4B R5 1/4B-55</p>	<p>FOR BEAVER</p>  <p>R6B</p>	<p>FOR HOOGS</p>  <p>MS-55(7)</p>	<p>FOR HOOGS</p>  <p>HOOG'S-110MM</p>	<p>FOR HOOGS</p>  <p>HOOG'S(R)</p>
---	--	--	---	---





ROUND KNIVES FOR EASTMAN

 <p>R114-HSS R80C1-114</p>	 <p>R123-HSS R80C1-123</p>	 <p>R147-HSS R80C1-147</p>	 <p>R149-HSS R80C1-149</p>	 <p>R4E R80C1-59</p>
 <p>R4E-141 R80C1-141</p>	 <p>R5E R80C1-101</p>	 <p>R5 1/4E-61 R80C1-61</p>	 <p>R6E</p>	 <p>R7E R7 1/2E</p>

ROUND KNIVES FOR HITAKA

 <p>R2 1/2H</p>	 <p>RE12</p>	 <p>R3 1/2H</p>	 <p>R5H</p>
--	---	--	--

ROUND KNIVES FOR MAIMIN

 <p>RS232</p>	 <p>R2 1/2M</p>	 <p>R4M</p>	 <p>R5M</p>	 <p>R5 1/4M-59 R6M,R7M</p>
--	--	--	---	---

ROUND KNIVES FOR KM

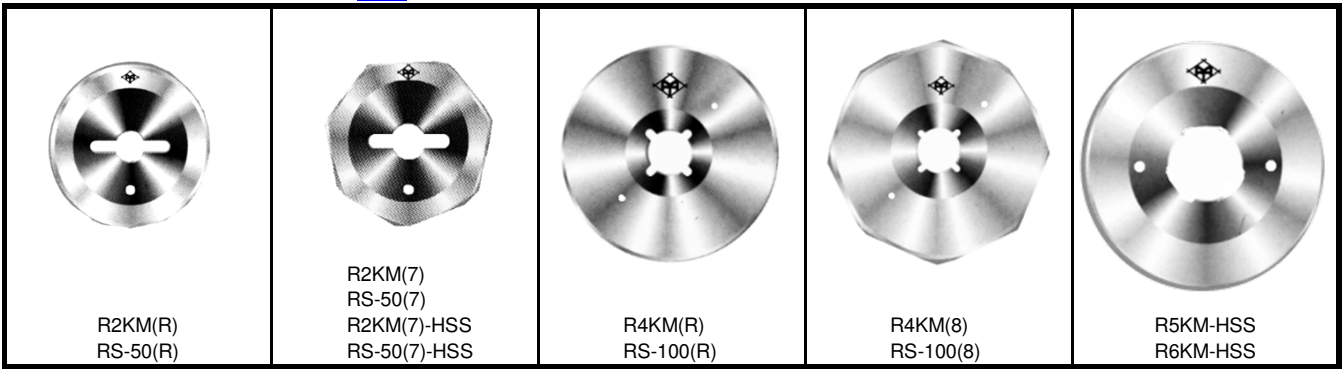

ROUND KNIVES FOR KURIS

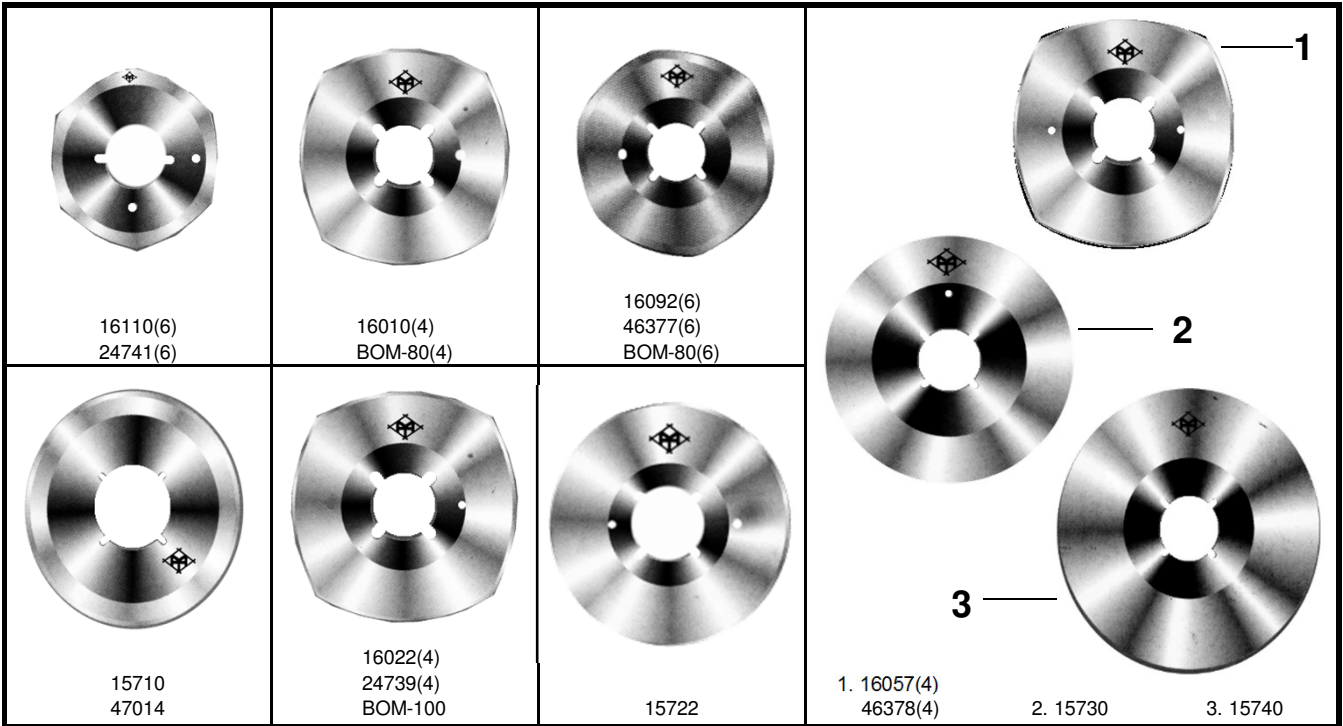

ROUND KNIVES FOR WOLF

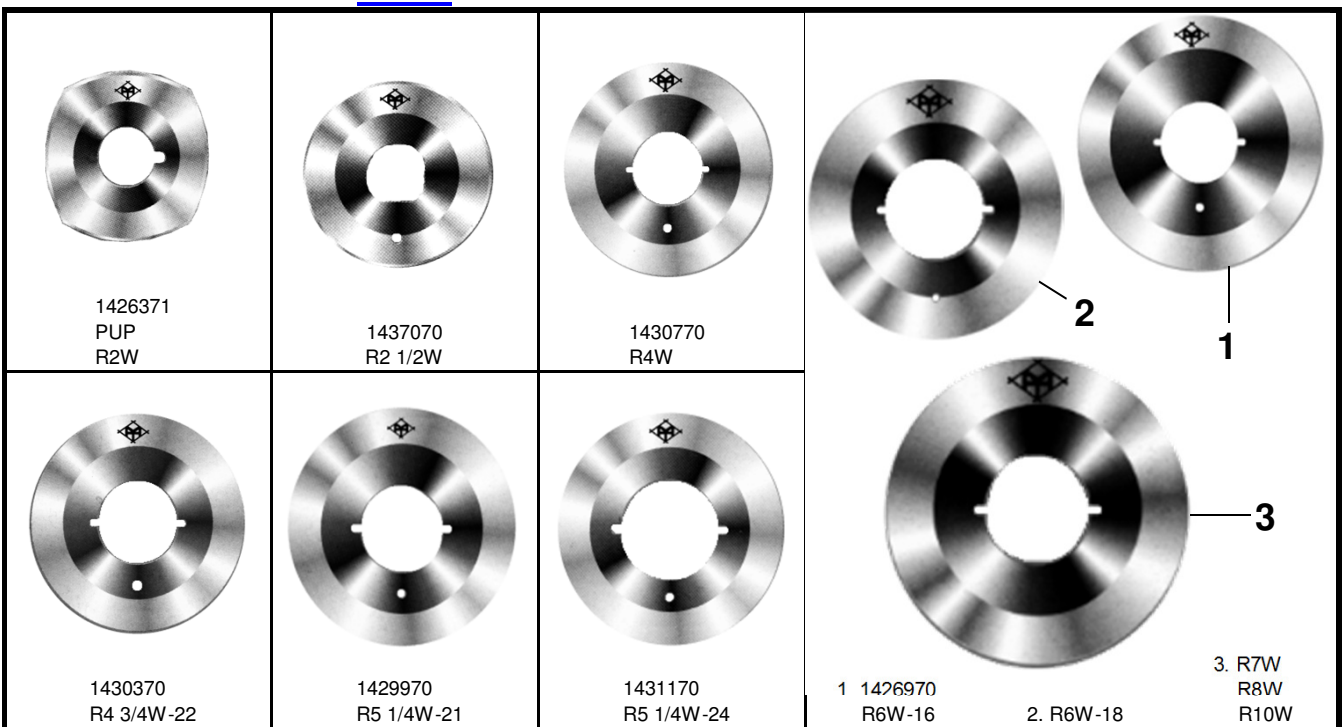

ROUND KNIVES FOR SUPRENA



ROUND KNIVES FOR VARIOUS

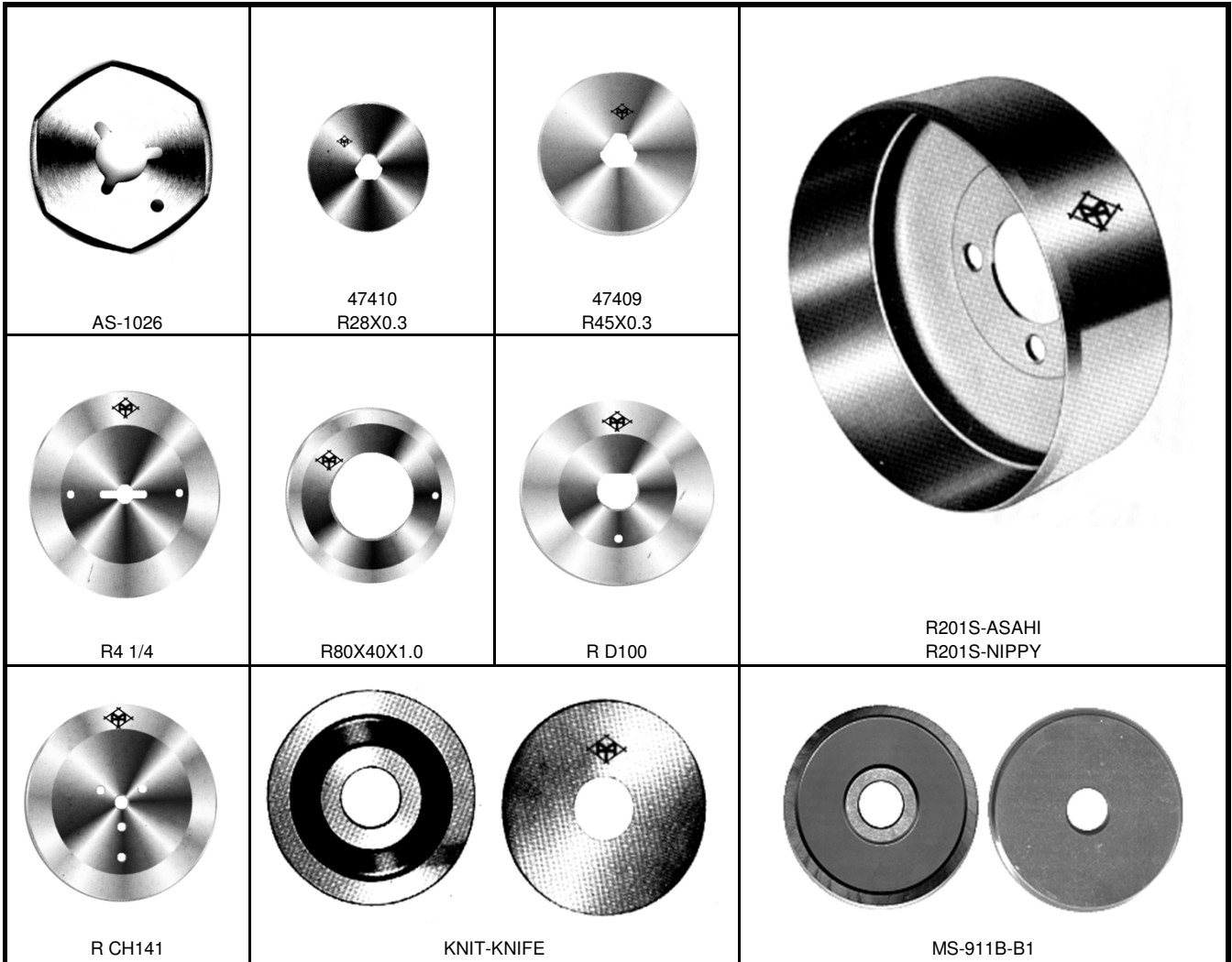

LOWER KNIFE FOR ROUND KNIFE

